

Education range

**We know education
washrooms.
Raising the standard
on your behalf.**

Venesta



We know washrooms.
After more than 120 years of innovation in partnership with our customers, we're still passionate about setting new standards of design, value, performance and reliability.

At Venesta, we live and breathe washrooms. Ever since the early days, innovation has been our inspiration, and product excellence our goal. With a commitment to setting the benchmark for design and performance, we've partnered with our clients to create solutions that they can rely on to satisfy the most challenging and demanding of briefs.

Today, our expert knowledge and pioneering attitude have inspired our range of education toilet cubicle and washroom systems. On the following pages you'll discover great product choice, value for money and uncompromising quality. As customer care is so important to us, you'll find we're breaking new ground in customer service too.

We invite you to see for yourself.

We know education.

From nurseries and children's play areas, to colleges and universities, we're committed to raising the standard of children and young adults' washrooms.

Safety

Children have a right to be safe at all times. With this in mind, we've introduced a number of important features into our designs. Low-level and shaped door options allow adult supervision where it's needed, while our clever safety hinges mean an end to trapped fingers. Our emergency release indicator bolts also come as standard across our education range, giving you extra peace of mind.

Privacy

Safety may be one of our top priorities, but we also believe that children have a right to privacy. That's why we give you the option of full height and increased privacy cubicle systems for secondary and further education. Not stopping there, our solutions also include urinal privacy screens.

Colours

Children love colour, whether it be bold designs or calming pastels, we've created the widest palette featuring 34 fresh and vibrant colours, ensuring you can create a washroom that children and young adults will enjoy using.

Hygiene

A hard-working washroom should also be one that's easy to maintain. That's why our solutions include features that make cleaning really easy. These include our Solid Surface washtroughs with individual drainers and minimal joints. Also, the solid grade laminate we use is totally impervious to water, which means it can withstand regular cleaning.

Anti-tamper

At Venesta, we work hard to ensure our stylish and robust designs encourage respect and discourage anti-social behaviour. Our solutions for secondary and further education washrooms feature metal frames renowned for strength and rigidity with durable metal fittings.

Value for money to suit your budget

A quality product doesn't always mean an expensive one. No one knows that better than Venesta. We strive to ensure that our products are competitively priced. Whatever your budget, you can expect a wide choice of excellent designs that are surprisingly affordable.

Performance

Our education cubicle ranges are available in all three performance options suitable for every type of wet or dry environment that's likely to be encountered. This allows you to specify the most appropriate option to meet the site requirements and your budget.

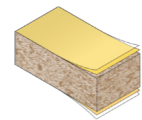

01 MFC

For dry environments with low risk of vandalism.

Panels are manufactured

from 19mm nominal thickness high performance moisture-resistant Melamine Faced Chipboard. Edges are lipped with ABS.

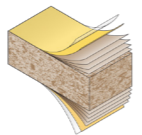

02 HPL

For more heavily used washrooms, panels are heat, scratch and impact resistant. Manufactured

from moisture-resistant chipboard faced with High Pressure Laminate, panels are 19mm nominal thickness. Edges are lipped with ABS.

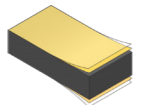

03 SGL

Solid Grade Laminate is extremely resistant to impact and all surfaces are

impervious to water. Panels are 13mm nominal thickness with polished black radiused edges.



01 Bold designs

With 34 fresh and vibrant colours to choose from, you can create washrooms that children enjoy using.

02 Total privacy

Full height designs with low floor clearances for maximum student privacy.

03 Easy cleaning

The solid grade laminate we use is totally impervious to water.

04 Right to feel safe

Low-level and shaped door options allow for adult supervision.

We know washroom solutions. Choice at your service.



2-11 years

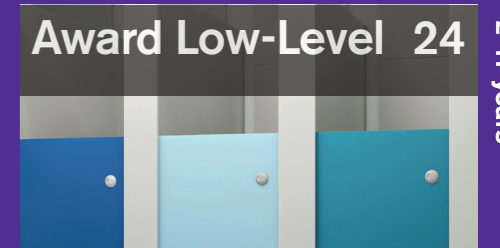
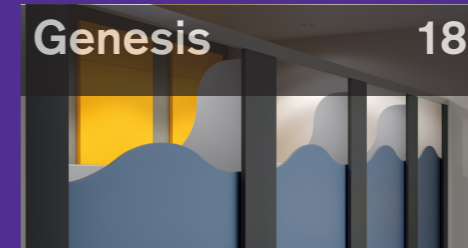
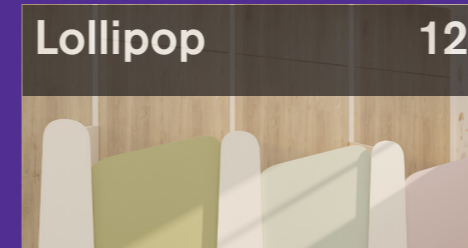

2-11 years

11+ years

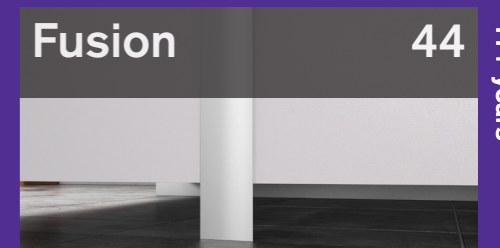

11+ years

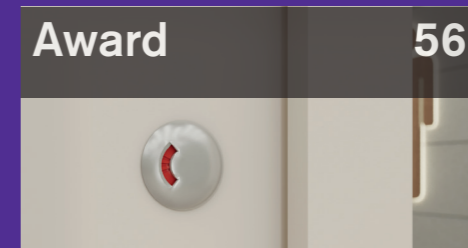
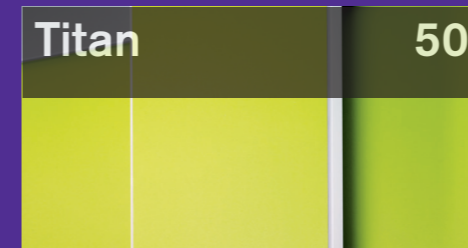

Panelling

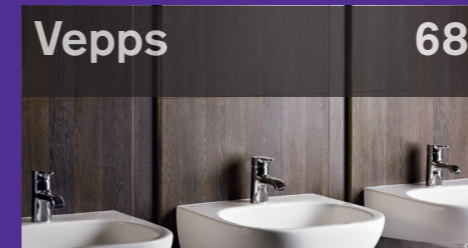

Panelling

Complementary



Complementary

2-11 years Our design team has gone to town to create spaces that challenge and delight young minds. Lollipop, Genesis and Award Low-Level are perfect combinations of fun, safety and hygiene - perfect for schools, crèches and children's play areas.



Door height options.

Balancing privacy needs with the need to supervise children is something we carefully consider with all our education washroom designs. The option of shaped and low height doors ensures you can achieve both.

- 01 Genesis door heights
- 02 Lollipop
- 03 Award Low-Level
- 04 Genesis

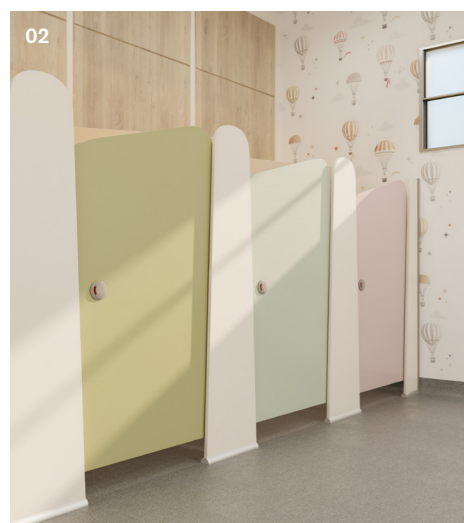

Get creative with colour.

Colour and design spark a child's imagination, so our design team is constantly working on new ideas to inspire young minds. Choose a fun and vibrant colour palette, or opt to combine pastel tones with a wood effect for a more understated, contemporary look. Select from our range of 34 laminate finishes shown below to create a washroom that children and young adults will enjoy using.



Lollipop

Designed to suit the specific needs of younger children, Lollipop is a free-standing cubicle system that delivers fun and safety in equal measures. Lollipop cubicles come with two door height options to choose from, specially designed safety hinges, easy to operate emergency release indicator bolts and optional magnetic catches.



01 Pilasters are fitted to the floor in an aluminium channel with concealed fixings, for strength and rigidity.

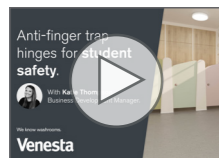

02 The shaped doors, pilasters and partitions allow for adult supervision.

See our anti-finger trap hinges in action by watching the dedicated video on our YouTube channel.

See p16-17 for Lollipop technical specifications.

Main image

Lollipop HPL cubicles in Olive, Duck Egg, Peony and Suede, with Vepps WC panelling in Soft Oak and Suede. Lollipop HPL vanity in Olive, Peony and Soft Oak with Sandringham 21 semi-recessed basins and Sandringham 21 self closing pillar taps.



Key features

- Unique shaped doors, pilasters and partitions to allow for adult supervision
- Available in 2 heights for younger children
- No headrail
- Total colour flexibility
- Anti-finger trap hinges
- Emergency release indicator bolts as standard
- Unique pedestal design, offering rigidity
- Complementing Lollipop vanity units

Case Study Lyons Hall Primary School

Lyons Hall Primary School in Essex is recognised as “outstanding” by Ofsted. Part of the Learning Pathways Academy Trust, Lyons Hall is a popular choice for local children. To meet the need for extra pupil places, a new teaching block was commissioned.

Laurie Wood Associates were chosen to undertake the development. Part of the first phase incorporated new washrooms for the early year’s pupils. Due to the breadth of product range, flexible service and a good past working relationship, Venesta were specified by Laurie Wood Associates to supply the new washrooms for the school’s pupils and staff.

Venesta’s popular Lollipop cubicles were specified for the early year’s children. Lollipop cubicles are designed specifically to meet the needs of young children. The range offers a fun design that will encourage children to use the toilet when needed, a key consideration for their physical and mental wellbeing in early school years. Aside from this, Lollipop toilet cubicles also offer great safety features such as anti-finger trap hinges and easy to operate emergency release indicator bolts or magnetic catches if preferred.

We know that the supervision of young children in primary school washrooms is also a priority. With this in mind, Lollipop cubicles offer low height, shaped doors and a free standing design which means there is no need for a headrail.

Read the full case study at www.venesta.co.uk



Technical Specifying Lollipop

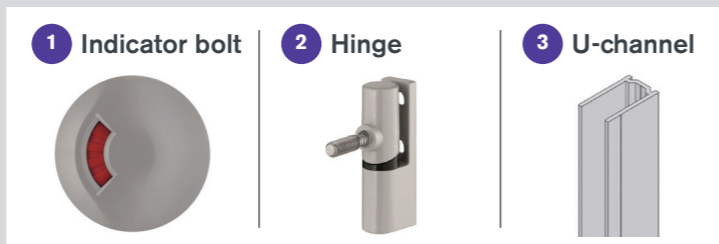
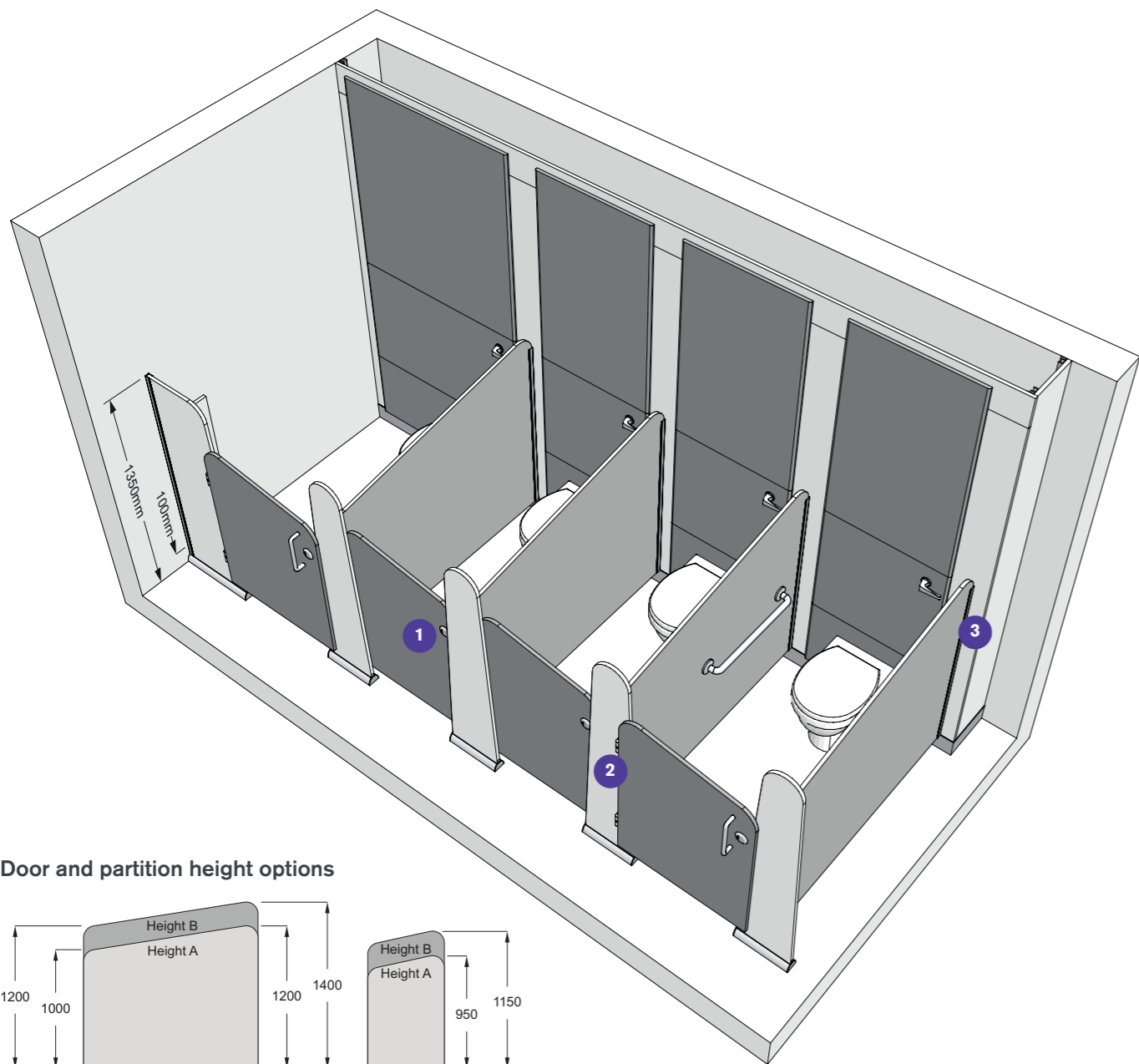

Dimensions

- Height option A**
Doors: 1050mm to highest point from floor level.
Partitions: 1300mm to highest point from floor level.
- Height option B**
Doors: 1250mm to highest point from floor level.
Partitions: 1500mm to highest point from floor level.
- Pilaster height**
1350mm from floor level.
- Maximum depth**

| | |
|-----|--------|
| MFC | 1500mm |
| HPL | 1500mm |
| SGL | 1500mm |
- Floor clearance**
100mm

Vanities

A complementary Lollipop vanity unit with shaped under panels is available.
Lollipop vanities available in 600mm high K2 profile.

Performance

- Available in three material options, Lollipop is suitable for every type of wet or dry environment, allowing you to specify the most appropriate option to meet the site requirements and your budget.
- MFC**
For dry environments with low risk of vandalism. Panels are manufactured from 19mm nominal thickness high performance moisture-resistant melamine faced chipboard. Edges lipped with ABS.
- HPL**
For more heavily used washrooms, panels are heat, scratch and impact resistant. Manufactured from moisture-resistant chipboard faced with high pressure laminate, panels are 19mm nominal thickness. Edges lipped with ABS.

SGL
Solid grade laminate is extremely resistant to impact and all surfaces are impervious to water. Panels are 13mm nominal thickness with polished black radiused edges.

Detailing

- Panels and doors**
Available in MFC, HPL and SGL.
- Colour finish**
MFC, HPL and SGL
34 colours from the standard range.
- Cubicle hardware**
Light Grey ABS and satin anodised aluminium.
- Edge treatment**
MFC and HPL
Matching ABS lipping.
SGL
Polished black radiused edge.
- Pilaster support system**
Steel vertical support post fitted to rear face of pilaster and concealed within satin anodised extruded U-channel.
- Cubicle hardware**
Indicator bolt
Light Grey ABS easy grip indicator bolt with emergency release facility and concealed fixings. Magnetic catch option in lieu of indicator bolts.
Hinge
Satin anodised aluminium rise and fall anti-finger trap safety hinge.
Pedestal
Pilasters taken to floor and fitted in an extruded aluminium U-channel.
Fixings
Partition to wall: Continuous satin anodised aluminium U-channel.
Pilaster to partition: Continuous satin anodised aluminium U-channel.
Pilaster to wall fixing: Continuous satin anodised aluminium U-channel.
- Accessories**
Coat hooks and toilet roll holders available.



Key features

- Shaped doors and partitions
- Available in 4 door heights
- Total colour flexibility
- Anti-finger trap hinges as standard
- Emergency release door mechanism
- Suitable for wet and dry environments
- Set back pedestals for a floating appearance

Genesis

Genesis is a popular choice for primary schools and nurseries thanks to its flexible design. Featuring four door height options and clever safety features, including anti-finger trap hinges and emergency release indicator bolts or optional magnetic catches, Genesis is ideal for the entire 2-11 age range.

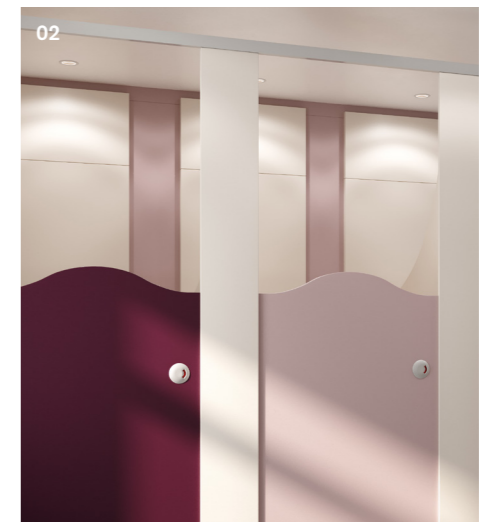

01 ABS indicator bolt fascia in Light Grey.

02 Headrail and shaped partition detail.

See p22-23 for Genesis technical specifications.

Main image
Genesis cubicles in Lime, Pacific, Rouge and Papaya. HPL vanity in Lime and Pacific with light pelmet in Rouge.



See why Genesis is our most popular education cubicle range by watching the dedicated video on our YouTube channel.

Case Study Alexander McLeod Primary School

“The Genesis cubicle range was the perfect solution for this primary school, plus the wide range of colours gave the school total design flexibility.”

Tony Starr, A F Starr

South East London-based Alexander McLeod Primary is a school where students model the high expectations and standards that are promoted at all times. The school aims to create an environment where all children can grow and flourish.

During a recent renovation project, attention was turned to the student washroom facilities. The existing toilet cubicles and vanity units were antiquated and hard for the facilities team to maintain, resulting in an uninviting space for the students to retreat to.

We worked with builders A F Starr to ensure fit-for-purpose education washroom systems were specified for the younger year's children. There was a requirement for washroom solutions that would be easy to clean and maintain whilst giving the staff the ability to supervise younger children using the facilities, where necessary.

Our popular Genesis toilet cubicles were specified in Solid Grade Laminate (SGL) in our Duck Egg and Suede finishes. Not only is SGL water and scratch proof, but its smooth surface will allow the school to uphold strict cleaning regimes to keep the school toilets sanitary for students.

With 1300mm high cubicle doors and shaped partitions, staff will be able to supervise students when required. Genesis' anti-finger trap hinges and emergency release indicator bolts made it an ideal cubicle choice.

The primary school opted for complementing SGL vanity units in matching colours. With its hardwearing, durable properties, SGL guarantees long-lasting washroom systems in busy environments such as schools.

Read the full case study at www.venesta.co.uk

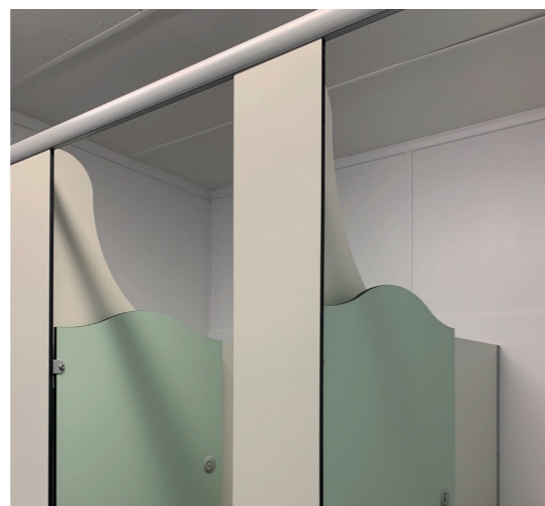

Technical Specifying Genesis

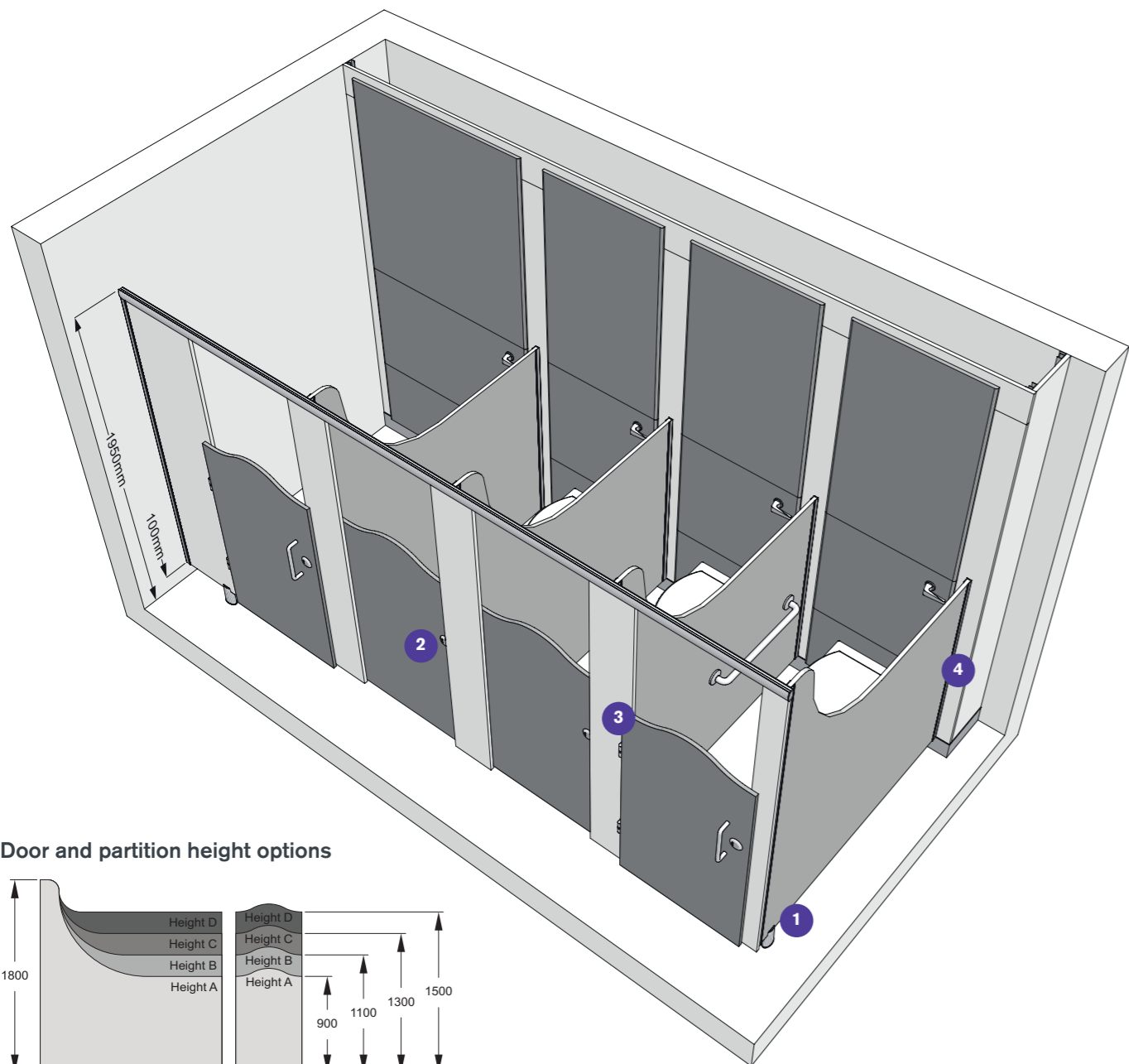

Door and partition height options

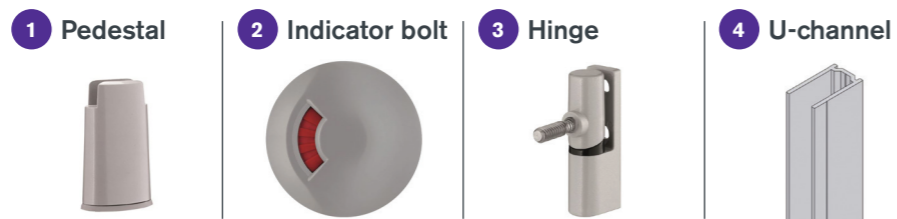
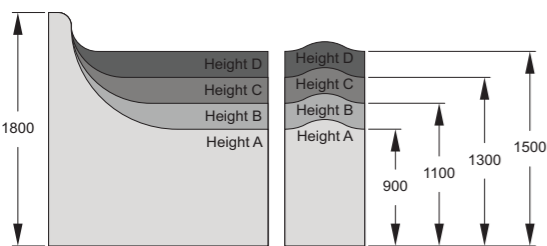

Dimensions

| | |
|----------------------------|--------|
| Overall height | 1950mm |
| Door height options | |
| Height A | 900mm |
| Height B | 1100mm |
| Height C | 1300mm |
| Height D | 1500mm |
| Maximum depth | |
| MFC | 2097mm |
| HPL | 2067mm |
| SGL | 1921mm |
| Floor clearance | 100mm |

Vanities

Genesis vanities are available in 600mm, 675mm, 750mm and 850mm height options.

Performance

Available in three material options, Genesis is suitable for every type of wet or dry environment, allowing you to specify the most appropriate option to meet the site requirements and your budget.

MFC
For dry environments with low risk of vandalism. Panels are manufactured from 19mm nominal thickness high performance moisture-resistant melamine faced chipboard. Edges lipped with ABS.

HPL
For more heavily used washrooms, panels are heat, scratch and impact resistant. Manufactured from moisture-resistant chipboard faced with high pressure laminate, panels are 19mm nominal thickness. Edges lipped with ABS.

SGL
Solid grade laminate is extremely resistant to impact and all surfaces are impervious to water. Panels are 13mm nominal thickness with polished black radiused edges.

Detailing

Panels and doors
Available in MFC, HPL and SGL.

Colour finish
MFC, HPL and SGL
34 colours from the standard range.
Cubicle hardware
Light Grey ABS, satin anodised effect powder coated zinc and satin anodised aluminium.

Edge treatment
MFC and HPL
Matching ABS lipping.
SGL
Polished black radiused edge.

Headrail
Easy to fix, one piece construction, in satin anodised aluminium with matching end cap.

Cubicle hardware
Indicator bolt
Light Grey ABS or satin anodised effect powder coated zinc easy grip indicator bolt and keep with emergency release facility and concealed fixings. Magnetic catch option in lieu of indicator bolts.

Hinge
Satin anodised effect powder coated zinc anti-finger trap safety hinge in Light Grey.

Pedestal
Height adjustable for uneven floors, with concealed fixings, available in Light Grey ABS or satin anodised effect powder coated zinc. Where possible, pedestals are fixed to partitions.

Fixings
Partition to wall: Continuous satin anodised aluminium U-channel.
Pilaster to partition: Continuous satin anodised aluminium U-channel.
Pilaster to wall: Continuous satin anodised aluminium U-channel.

Accessories
Coat hooks and toilet roll holders available.

Award Low-Level

Versatile, economical and easy to assemble. Award Low-Level gives you a tried and tested bespoke solution that works equally well in wet or dry environments. Plus, it comes in our complete range of 34 laminate finishes.

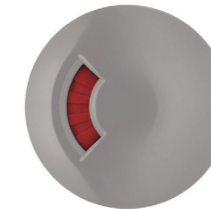

The fittings for Award Low-Level come in either Light Grey ABS or Light Grey powder coated aluminium.



Access our cubicles in an emergency without the need to remove the door or cause damage to the lock. Watch the video on our YouTube channel.

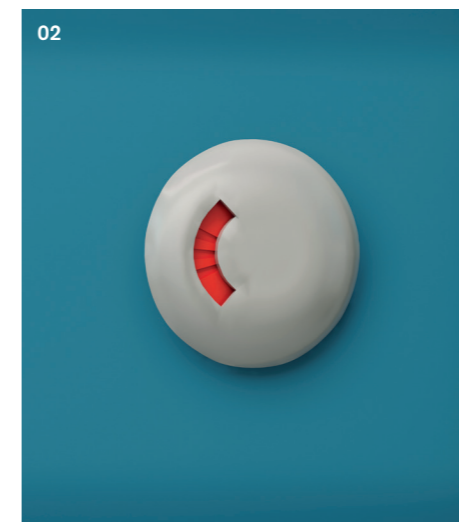

01 Set back pedestal for floating appearance.

02 ABS indicator bolt fascia in Light Grey.

See p26-27 for Award Low-Level technical specifications.

Key features

- 2 door height options
- Anti-finger trap hinges
- Emergency release indicator bolts
- 34 laminate colour options
- Suitable for wet and dry environments
- Simple installation
- Economical

Main image

Award Low-Level cubicles in Pacific, Hydrangea, Peacock, Teal and Cloud with Vepps WC panelling in Cloud and Porcelain. HPL K2 profile vanity unit in Shadow and Cloud with a Sandringham 21 500 semi-recessed basin and a SanCeram basin mounted self-closing mixer tap. SGL perimeter bench in Teal and light grey coat hooks.

Technical Specifying Award Low-Level

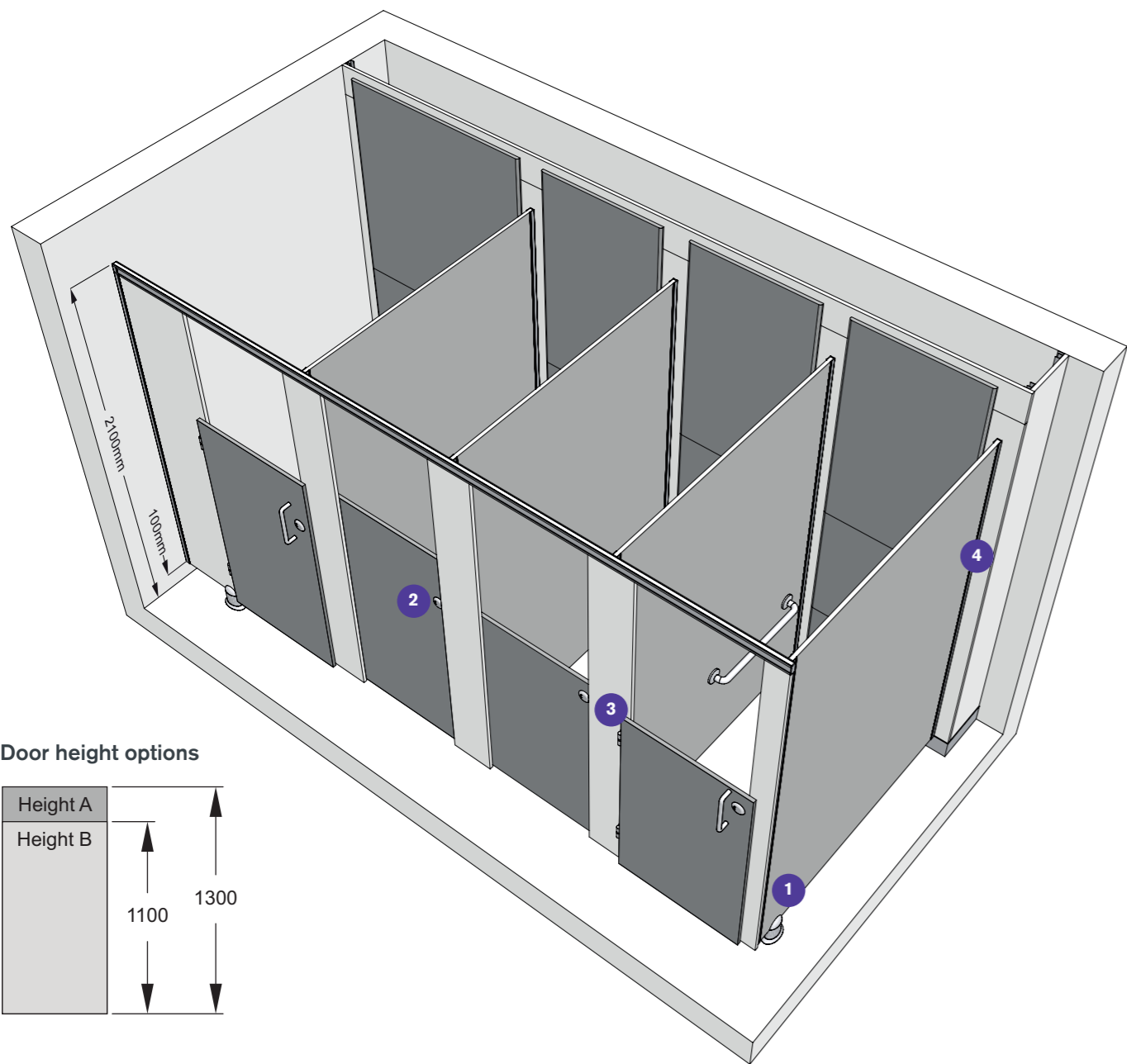

Door height options

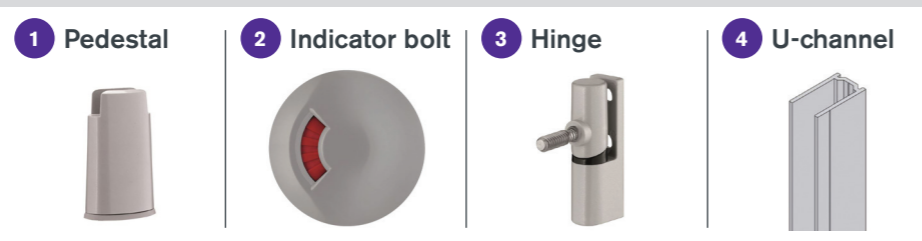
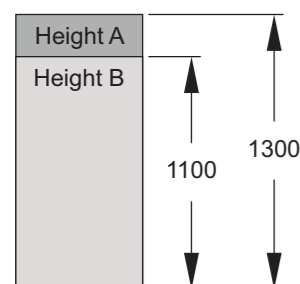

Dimensions

| | |
|----------------------------|--------|
| Overall height | 2100mm |
| Door height options | |
| Height A | 1300mm |
| Height B | 1100mm |
| Maximum depth | |
| MFC | 2097mm |
| HPL | 2067mm |
| SGL | 1921mm |
| Floor clearance | 100mm |

For standard height option see p56.

Performance

Available in three material options, Award Low-Level is suitable for every type of wet or dry environment, allowing you to specify the most appropriate option to meet site requirements and your budget.

MFC
For dry environments with low risk of vandalism. Panels are manufactured from 19mm nominal thickness high performance moisture-resistant melamine faced chipboard. Edges lipped ABS.

HPL
For more heavily used washrooms, panels are heat, scratch and impact resistant. Manufactured from moisture-resistant chipboard faced with high pressure laminate, panels are 19mm nominal thickness. Edges lipped ABS.

SGL
Solid grade laminate is extremely resistant to impact and all surfaces are impervious to water. Panels are 13mm nominal thickness with polished black radiused edges.

Detailing

Panels and doors
Available in MFC, HPL and SGL.

Colour finish
MFC, HPL and SGL
34 colours from the standard range.
Cubicle hardware
Light Grey ABS or satin anodised effect powder coated zinc.

Edge treatment
MFC and HPL
Matching ABS lipping.
SGL
Polished black radiused edge.

Headrail
Rigid satin anodised aluminium headrail with matching end cap.

Cubicle hardware
Indicator bolt
Easy grip indicator bolt with emergency release facility and concealed fixings.

Hinge
Anti-finger trap satin anodised aluminium rise and fall butt hinge. Outward opening hinge option available.

Pedestal
Height adjustable for uneven floors, with concealed fixings. Where possible, pedestals are fixed to partitions.

Fixing
Partition to wall: Continuous satin anodised aluminium u-channel.
Pilaster to partition: Continuous satin anodised aluminium u-channel.
Pilaster to wall: Continuous satin anodised aluminium u-channel.

Accessories
Coat hooks and toilet roll holders available.

11+ years Cleanliness, ease of maintenance, privacy, vandal resistance. With tough demands like these, you'll be glad to know we build these things into our designs as a matter of course. The results speak for themselves.

11+ years



Centurion

Centurion's strength comes from a number of key details. Wall channels offer extra rigidity and pilasters extend to the floor, so no pedestals are required. Easy to clean, robust and vandal-proof, these cubicles come with hardwearing fittings.

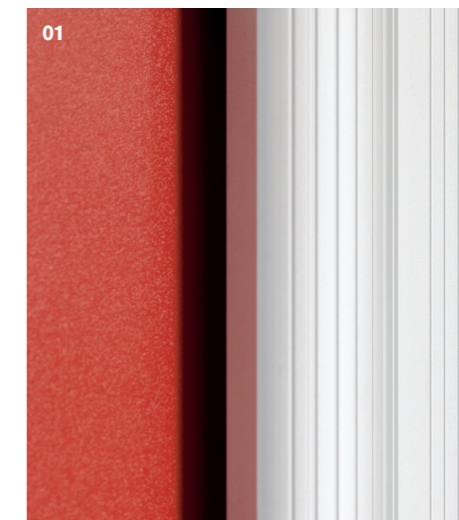

01 High strength, fluted satin anodised aluminium pilaster.

02 Indicator bolts come with emergency release facility as standard.

See p36-37 for Centurion technical specifications.

Main image

Centurion HPL with satin anodised aluminium pilasters and Vepps HPL panels.

Key features

- Robust frame design
- Fluted satin anodised aluminium pilasters
- Renowned for strength and rigidity
- Hardwearing and easy to maintain
- Easily adjustable hinges
- Emergency release indicator bolts
- A choice of 34 on-trend laminates

Centurion Full Height

A handsome design in any setting, Centurion Full Height cubicles are supplied with floor to ceiling partitions and overpanels above the doors, creating a private space. So if you're looking for extra privacy when specifying cubicles, Centurion Full Height will satisfy your needs.



01 Floor fixed satin anodised aluminium pilasters with 5mm floor clearance.

02 Fluted satin anodised aluminium pilaster and overpanels above doors.

See p36-37 for Centurion Full Height technical specifications.

Main image

Centurion Full Height SGL cubicles with satin anodised aluminium pilasters.



Key features

- Robust frame design
- Fluted satin anodised aluminium pilasters for added strength
- Overpanels above doors with full height partitions offers privacy for users
- Easily adjustable hinges
- Floor to ceiling for increased privacy
- Emergency release indicator bolts

Case Study Tudor Grange Academy

“To meet the rigorous demands of this type of environment, all facilities in our academy have to be robust, efficient and fit for purpose. Centurion has fulfilled these requirements, and has given an excellent finished appearance.”

Graham Turner, Facilities Manager at Tudor Grange Academy.

Rated 'Outstanding' by Ofsted, Tudor Grange Academy is a comprehensive school in South Solihull. Also awarded 'World Class School' status, Tudor Grange is committed to delivering a high-quality educational experience for its 1,600 students.

The Academy strives to create a safe and secure space for its students and staff, giving everyone the opportunity to achieve and succeed. They wanted to make the new school washrooms a more open and less intimidating space for all students. The washrooms would also need to be easy for staff to supervise, where needed.

Tudor Grange Academy had a requirement for robust, high specification toilet cubicles that would be able to withstand the rigours of a large and busy Academy; as well as a panelling system that would be easy to maintain.

Renowned for strength and rigidity, Solihull Council chose the Centurion Full Height toilet cubicle range for six male and female unisex school toilets around the campus.

Robust Centurion Full Height cubicles specified in dark grey laminate, along with pre-plumbed Vepps panelling in yellow and green help create a positive, bright and airy unisex washroom environment. Combine that with the hardwearing materials chosen, Tudor Grange Academy's washrooms could withstand even the most boisterous teenage antics.

Read the full case study at www.venesta.co.uk



Technical Specifying Centurion

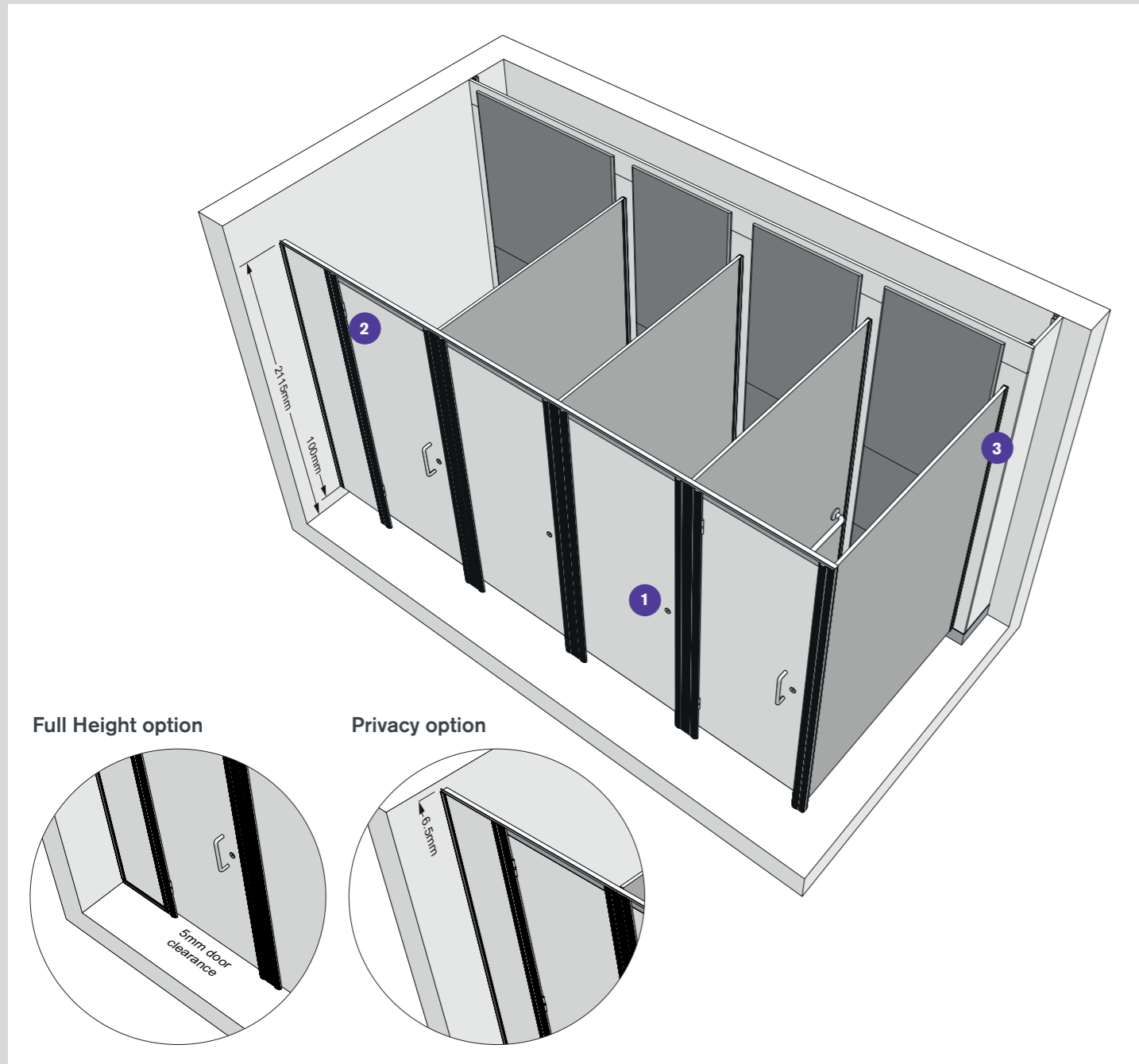

Dimensions

Centurion
Overall height
 2100mm

Maximum depth
 MFC 2092mm
 HPL 2062mm
 SGL 1922mm

Floor clearance
 100mm

Minimum ceiling clearance
 10mm

Centurion Full Height
Maximum height
 MFC 2774mm
 HPL 2774mm
 SGL 2774mm

Maximum depth
 MFC 2040mm
 HPL 2040mm
 SGL 1922mm

Floor clearance
 5mm at doors
 0mm at partitions and pilasters

Minimum ceiling clearance
 10mm

Centurion Privacy
Maximum height
 MFC 2816mm
 HPL 2816mm
 SGL 2816mm

Maximum depth
 MFC 2040mm
 HPL 2040mm
 SGL 1922mm

Floor clearance
 5mm at doors
 0mm at partitions and pilasters

Minimum ceiling clearance
 6.5mm

Performance

Available in three material options, Centurion is suitable for every type of wet or dry environment, allowing you to specify the most appropriate option to meet the site requirements and your budget.

MFC
 For dry environments with low risk of vandalism. Panels are manufactured from 19mm nominal thickness high performance moisture-resistant melamine faced chipboard. Edges lipped with ABS.

HPL
 For more heavily used washrooms, panels are heat, scratch and impact resistant. Manufactured from moisture-resistant chipboard faced with high pressure laminate, panels are 19mm nominal thickness. Edges lipped with ABS.

SGL
 Solid grade laminate is extremely resistant to impact and all surfaces are impervious to water. Panels are 13mm nominal thickness with polished black radiused edges.

Detailing

Panels and doors
 Available in MFC, HPL and SGL.

Colour finish
MFC, HPL and SGL
 34 colours from the standard range.
Cubicle hardware
 Satin anodised aluminium and satin anodised effect powder coated zinc.

Edge treatment
MFC and HPL
 Matching ABS lipping.
SGL
 Polished black radiused edge.

Headrail
 High strength extruded satin anodised aluminium headrail.

Pilasters
 High strength extruded fluted satin anodised aluminium pilasters which extend down to floor level and are fixed to floor using mounting blocks.

Cubicle hardware
Indicator bolt
 Satin anodised aluminium slide operated bolt with circular faceplate and emergency release facility. Faceplate and keep with concealed fixings.

Hinge
 Standard and Full Height: Anti-finger trap satin anodised effect powder coated zinc rise and fall hinge. Outward opening hinge option available.
 Privacy: Satin anodised effect powder coated zinc 5mm nominal door clearance rise and fall hinge. This is not an anti-finger trap hinge.

Fixings
 Partition to wall: Continuous satin anodised aluminium U-channel.

Accessories
 Coat hooks and toilet roll holders available.



Unity

Unity's floating, flush front always makes a big impact. Great value without compromising on quality or functionality, the simple and striking design can be specified in standard or full height and is available in five materials and our full range of colours.



01 Slimline profile headrail in satin anodised aluminium finish. 3 part fixing system allowing cubicles to finish only 20mm below ceiling height.

02 Pedestals are fitted to partitions to give the range its floating appearance.

Main image

Unity ColourCoat cubicles in Orange (RAL2008) with Solid Surface H2 profile vanity.



See p42-43 for Unity technical specifications.



See why Unity is our most popular cubicle by watching the dedicated video on our YouTube channel.

Key features

- Minimal look with clean lines
- Floating appearance
- Flush fronted
- Satin anodised aluminium and stainless steel fittings
- Full height and increased privacy options available
- Choose from 34 standard laminate colours or 10 RAL finishes for ultimate design flexibility

Case Study Isaac Newton Academy

“Venesta’s products are great value and the staff are helpful and committed; their full height cubicles are ideal for areas where privacy is essential.”

Akos Juhasz, Architect.

Rated outstanding by Ofsted, Isaac Newton Academy is a high-achieving school that accommodates boys and girls aged between 11 and 18 years. The Academy’s new washroom areas needed to be as secure and private as possible for students, whilst looking bright and inviting to use. The facilities also needed to offer staff the ability to easily supervise the communal areas.

Skanska managed the design and build of the Academy and the unisex washroom facility was located in an open area and had to be easy to supervise, offering complete visual and audible privacy for the pupils.

Our Unity toilet cubicle system was chosen by the client due to its seamless, flush-fronted design and full height doors which allow for total privacy. Unity also has a low floor clearance for added privacy and robust fittings, making the toilet cubicles hardwearing and durable for those bustling school washrooms.

The indicator bolt has a discreet emergency release provision, making it the ideal choice for education environments, where safety is of paramount importance. These cleverly designed indicator bolts mean emergency access can be gained without the need for removing or damaging the cubicle doors.

Read the full case study at www.venesta.co.uk

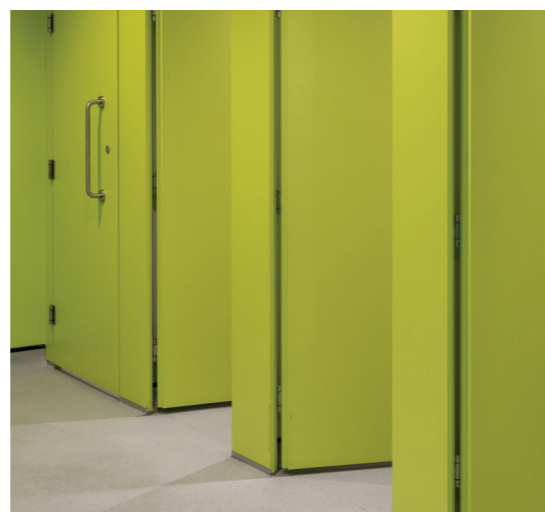

Technical Specifying Unity

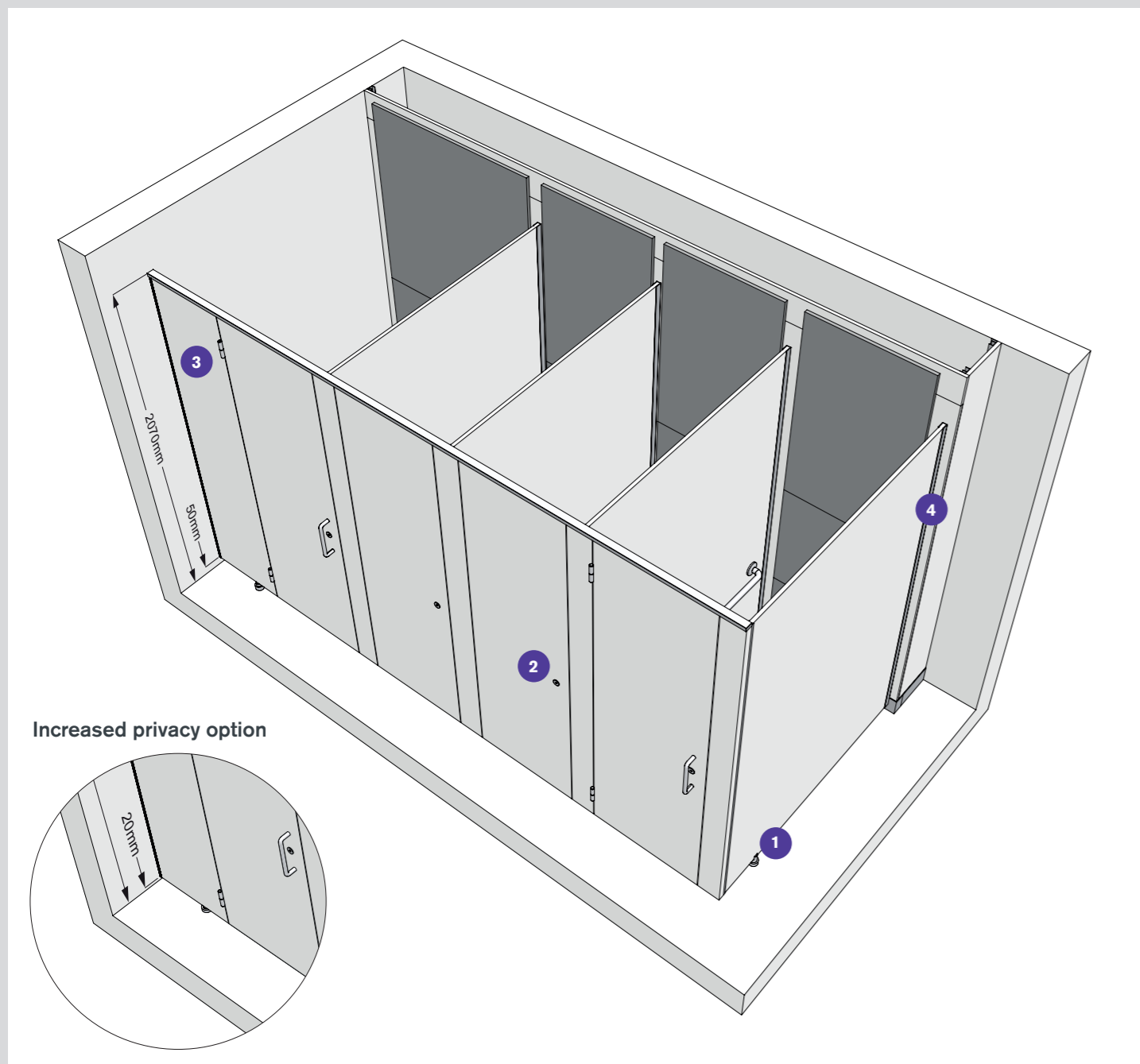

1 Pedestal



2 Indicator bolt



2 Indicator bolt



3 Hinge



4 U-channel

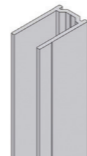

Dimensions

| | |
|-----------------------|--------|
| Unity | |
| Overall height | |
| HPL | 2070mm |
| SGL | 2065mm |
| ColourCoat | 2070mm |
| High Gloss | 2070mm |

| | |
|----------------------|--------|
| Maximum depth | |
| HPL | 2084mm |
| SGL | 1921mm |
| ColourCoat | 2084mm |
| High Gloss | 2084mm |

| | |
|------------------------|------|
| Floor clearance | 50mm |
|------------------------|------|

| | |
|----------------------------------|------|
| Minimum ceiling clearance | 20mm |
|----------------------------------|------|

| | |
|--------------------------|--------|
| Unity Full Height | |
| Maximum height | |
| HPL | 2840mm |
| SGL | 2823mm |
| ColourCoat | 2840mm |
| High Gloss | 2840mm |

| | |
|----------------------|--------|
| Maximum depth | |
| HPL | 2084mm |
| SGL | 1921mm |
| ColourCoat | 2084mm |
| High Gloss | 2084mm |

| | |
|------------------------|------|
| Floor clearance | 50mm |
|------------------------|------|

| | |
|----------------------------------|------|
| Minimum ceiling clearance | 20mm |
|----------------------------------|------|

| | |
|----------------------------------|--------|
| Unity Full Height Privacy | |
| Overall height | |
| HPL | 2040mm |
| SGL | 2035mm |
| ColourCoat | 2040mm |
| High Gloss | 2040mm |

| | |
|-----------------------|--------|
| Maximum height | |
| HPL | 2810mm |
| SGL | 2793mm |
| ColourCoat | 2810mm |
| High Gloss | 2810mm |

| | |
|----------------------|--------|
| Maximum depth | |
| HPL | 2035mm |
| SGL | 1921mm |
| ColourCoat | 2035mm |
| High Gloss | 2035mm |

| | |
|------------------------|---|
| Floor clearance | 20mm (cubicle standard height will drop by 30mm and partitions will sit on privacy skirting with end cap) |
|------------------------|---|

| | |
|----------------------------------|------|
| Minimum ceiling clearance | 20mm |
|----------------------------------|------|

Performance

Available in four material options, Unity is suitable for every type of wet or dry environment, allowing you to specify the most appropriate option to meet the site requirements and your budget.

HPL

For more heavily used washrooms, panels are heat, scratch, impact and cigarette burn resistant. Moisture-resistant chipboard faced with high pressure laminate. Edges lipped with ABS. Doors and pilasters are 35mm nominal thickness with an MDF core, partitions are 19mm nominal thickness.

SGL

Solid grade laminate is extremely resistant to impact and all surfaces are impervious to water. Panels are 13mm nominal thickness with polished black radiused edges.

ColourCoat

Panels have an MDF core. Doors and pilasters are sprayed with a coat of primer and finished with 20% gloss pigmented lacquer. Doors and pilasters are 35mm nominal thickness, partitions are 18mm nominal thickness.

ColourCoat High Gloss

Panels have an MDF core. Doors and pilasters are sprayed with a coat of primer and finished with 80% gloss pigmented lacquer. Doors and pilasters are 35mm nominal thickness, partitions are 18mm nominal thickness.

Detailing

Panels and doors

Available in HPL, SGL, ColourCoat and ColourCoat High Gloss.

Colour finish

HPL and SGL
34 colours from the standard range.
ColourCoat and ColourCoat High Gloss
10 colours.

Cubicle hardware

Satin anodised aluminium and stainless steel.

Edge treatment

HPL
Matching ABS lipping.
SGL
Polished black radiused edge.

ColourCoat

Edges sprayed with a coat of primer and finished with 20% gloss pigmented lacquer.

ColourCoat High Gloss

Edges are sprayed with a coat of primer and finished with 80% gloss pigmented lacquer.

Headrail

Slimline aluminium profile headrail in satin anodised finish. 3 part fixing system which allows cubicles to finish only 20mm below ceiling height.

Cubicle hardware

Indicator bolt

Satin anodised aluminium flip indicator bolt with emergency release facility and faceplate. 35mm doors have an internal mortice lock. All with concealed fixings.

Hinge

Satin anodised aluminium modular rise and fall butt hinge, set to fall open or closed.

Pedestal

50mm FC: Adjustable satin anodised aluminium pedestal with a ± 5 mm tolerance.

20mm FC: In-line stainless steel pedestal with a ± 5 mm tolerance. Satin anodised aluminium partition skirting.

Fixings

Partition to wall: Satin anodised aluminium U-channel.

Pilaster to partition: Satin anodised aluminium U-channel.

Pilaster to wall: Satin anodised aluminium L-angle 13mm (SGL), E-channel 36mm (HPL, CC and CCHG).

Accessories

Coat hooks and toilet roll holders available.

Fusion

With an ultra-strong metal frame and slimline pilasters that fix to the floor for added rigidity. Fusion is an innovation all of its own, combining strength and modernity in equal measure.

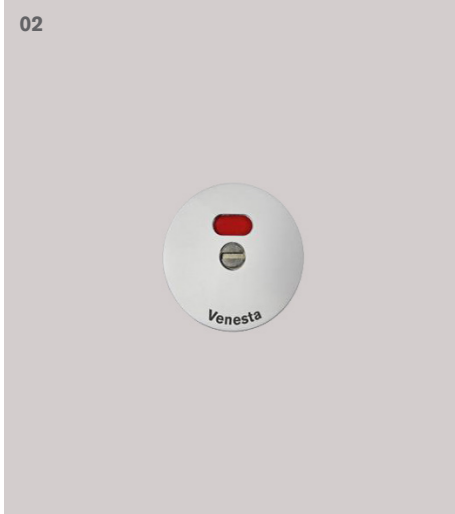

01 Floor fixed pilasters for added rigidity.

02 Discreet, slimline indicator bolt faceplate with emergency release facility.

See p48-49 for Fusion technical specifications.

Main image

Fusion MFC cubicles and Solid Surface WT5 profile washtrough.



Key features

- Full satin anodised aluminium frame
- Floor fixed pilasters for added rigidity
- Uniform slimline pilasters and headrail
- Contemporary minimal design
- Sleek satin anodised aluminium fittings
- Complete colour flexibility
- Economical
- Full height option available for increased privacy

Case Study Selby High School

Our metal-framed Fusion toilet cubicles offered Selby High School a slimline, contemporary washroom solution to help maximise space.

Selby High school undertook a £1.2m development to construct a new PE facilities block on the school grounds. As a school offering numerous extra-curricular activities, they needed to provide an adequate number of toilets to cater to the volume of students using the washrooms.

Selby High required a robust solution suitable for both wet and dry environments for their washroom and new shower facilities. The facilities needed to provide privacy, whilst maximising the school's space to provide an adequate number of cubicles.

Fusion was chosen for its contemporary, discreet, slimline fittings to maximise space within the washrooms. The strong metal frame, combined with slimline pilasters that fix to the floor for added rigidity made Fusion the perfect choice.

The school anticipated the new PE block to be a busy part of the school and therefore specified their toilet, shower and changing cubicles in Solid Grade Laminate (SGL) as it's designed to meet the most stringent specifications of durability and hygiene.

Using Fusion cubicles meant that Selby High School was able to achieve the durable and robust washroom area they required. The design flexibility and colour choices available meant they could choose a bold yet sophisticated design that reflected their school colours.

To complement the Venesta toilet cubicles, Selby High also specified Frameduct and SGL vanity units for their new facilities.

Read the full case study at www.venesta.co.uk



Technical Specifying Fusion

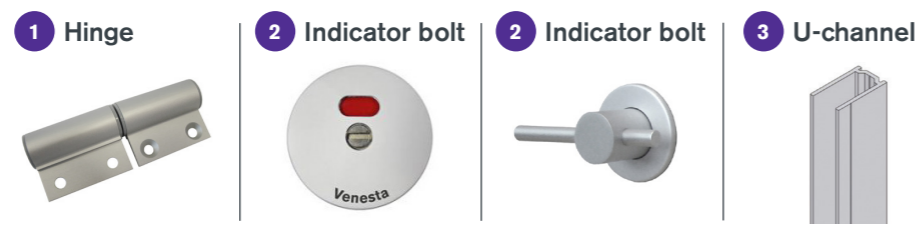
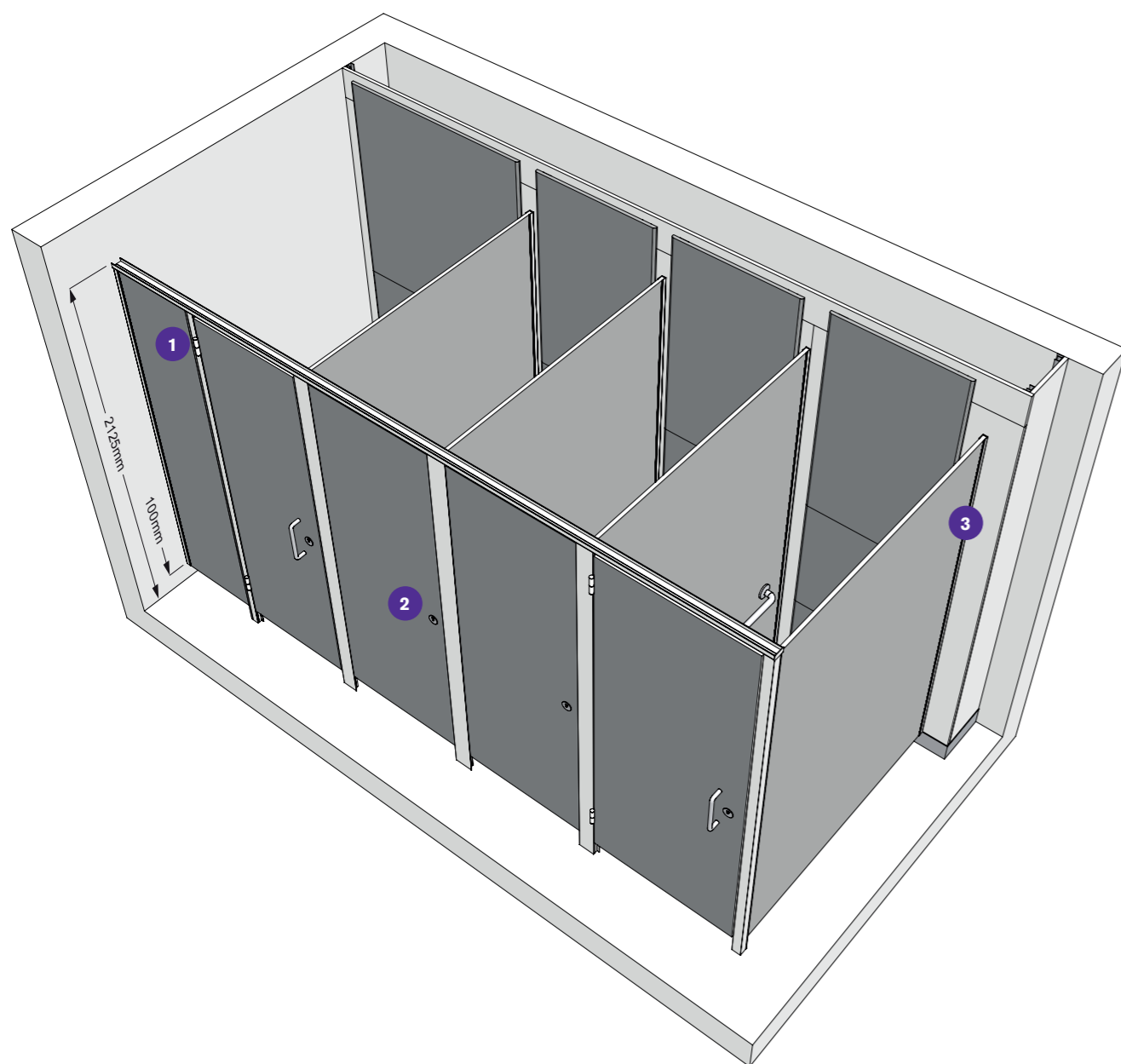

Dimensions

| | |
|----------------------------------|--------|
| Fusion | |
| Overall height | |
| MFC | 2125mm |
| HPL | 2125mm |
| SGL | 2125mm |
| Maximum depth | |
| MFC | 2090mm |
| HPL | 2060mm |
| SGL | 1930mm |
| Floor clearance | 100mm |
| Minimum ceiling clearance | 150mm |
| Fusion Full Height | |
| Maximum height | |
| MFC | 2895mm |
| HPL | 2895mm |
| SGL | 2895mm |
| Maximum depth | |
| MFC | 2090mm |
| HPL | 2060mm |
| SGL | 1930mm |
| Floor clearance | 100mm |
| Minimum ceiling clearance | 150mm |

Performance

Available in three material options, Fusion is suitable for every type of wet or dry environment, allowing you to specify the most appropriate option to meet the site requirements and your budget.

MFC

For dry environments with low risk of vandalism. Panels are manufactured from 19mm nominal thickness high performance moisture-resistant melamine faced chipboard. Edges lipped with ABS.

HPL

For more heavily used washrooms, panels are heat, scratch and impact resistant. Manufactured from moisture-resistant chipboard faced with high pressure laminate, panels are 19mm nominal thickness. Edges lipped with ABS.

SGL

Solid grade laminate is extremely resistant to impact and all surfaces are impervious to water. Panels are 13mm nominal thickness with polished black radiused edges.

Detailing

Panels and doors

Available in MFC, HPL and SGL.

Colour finish

MFC, HPL and SGL

34 colours from the standard range.

Cubicle hardware

Satin anodised aluminium.

Edge treatment

MFC and HPL

Matching ABS lipping.

SGL

Polished black radiused edge.

Headrail

Satin anodised aluminium.

Pilasters

High strength, slimline extruded satin anodised aluminium, incorporating moulded channel to secure partition.

Cubicle hardware

Indicator bolt

Satin anodised flip indicator bolt with circular faceplate, emergency release facility and matching keep.

Hinge

Rise and fall satin anodised aluminium hinges with adjustable self-lubricating cams to allow the door to fall closed, open or ajar. Lift off hinge to allow emergency access.

Pedestal

No pedestal required as the pilasters extend to floor level and are fixed to floor mounting blocks.

Fixings

Partition to wall: Continuous satin anodised aluminium U-channel.

Accessories

Coat hooks and toilet roll holders available.

Titan

Titan certainly lives up to its name. Boasting a full height design with low floor clearance for privacy and partitions with rigid wall channels, for strength where you need it most.

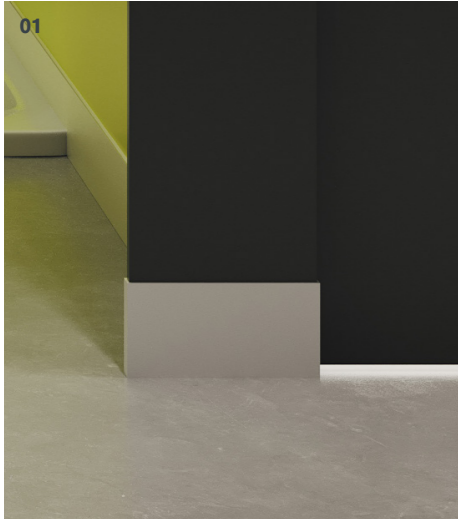

01 Unique shoe in satin anodised aluminium.

02 Satin anodised aluminium headrail.

See p54-55 for Titan technical specifications.

Main image
Titan HPL cubicles.



Full height cubicles offer increased privacy for users. Watch the dedicated video on our YouTube channel.



Key features

- Floor to ceiling cubicles guarantee total privacy for users
- Partition privacy skirting channel for 0mm gaps under partitions
- Suitable for wet and dry environments
- Unique satin anodised aluminium shoe
- Wall channels for additional rigidity
- Emergency release indicator bolts
- Anti-finger trap hinges as standard

Case Study The Leigh Academy

“The cubicles are what we’re best pleased with; they’re well made and will stand the heavy flow of traffic through them. Users have been pleased to see the transformation of old tired facilities to a bright inviting area.”

Nicholas Campbell, Site Manager at The Leigh Academy.

After 11 years since the reconstruction of The Leigh Academy’s original school buildings, the washrooms had become tired and were in need of rejuvenation. The thoughtful design of the school provides inspirational spaces for students and staff, so it was crucial that the new washrooms would uphold existing standards, whilst taking into consideration respect for student privacy, ease of supervision and quality.

The academy expressed a desire to remove doors upon entry to all toilet facilities, to act as a deterrent against anti-social behaviour. This was possible with our full height Titan cubicle range, providing maximum privacy whilst maintaining the integrity of student safety with emergency access features.

Titan has minimal floor and ceiling clearances, meaning no one can peep under or over cubicle doors, further reducing opportunities for bullying. In the event of an emergency, staff can release doors with our rapid release indicator bolts, without having to remove doors or cause damage to the cubicles.

The use of Solid Grade Laminate (SGL), specified in a light grey colour, has also helped to keep maintenance efforts low. The smooth surface of SGL is easy to clean and is totally waterproof so it can endure regular cleaning. With the help of robust fittings it is also impact, heat and scratch-resistant.

Read the full case study at www.venesta.co.uk



Technical Specifying Titan

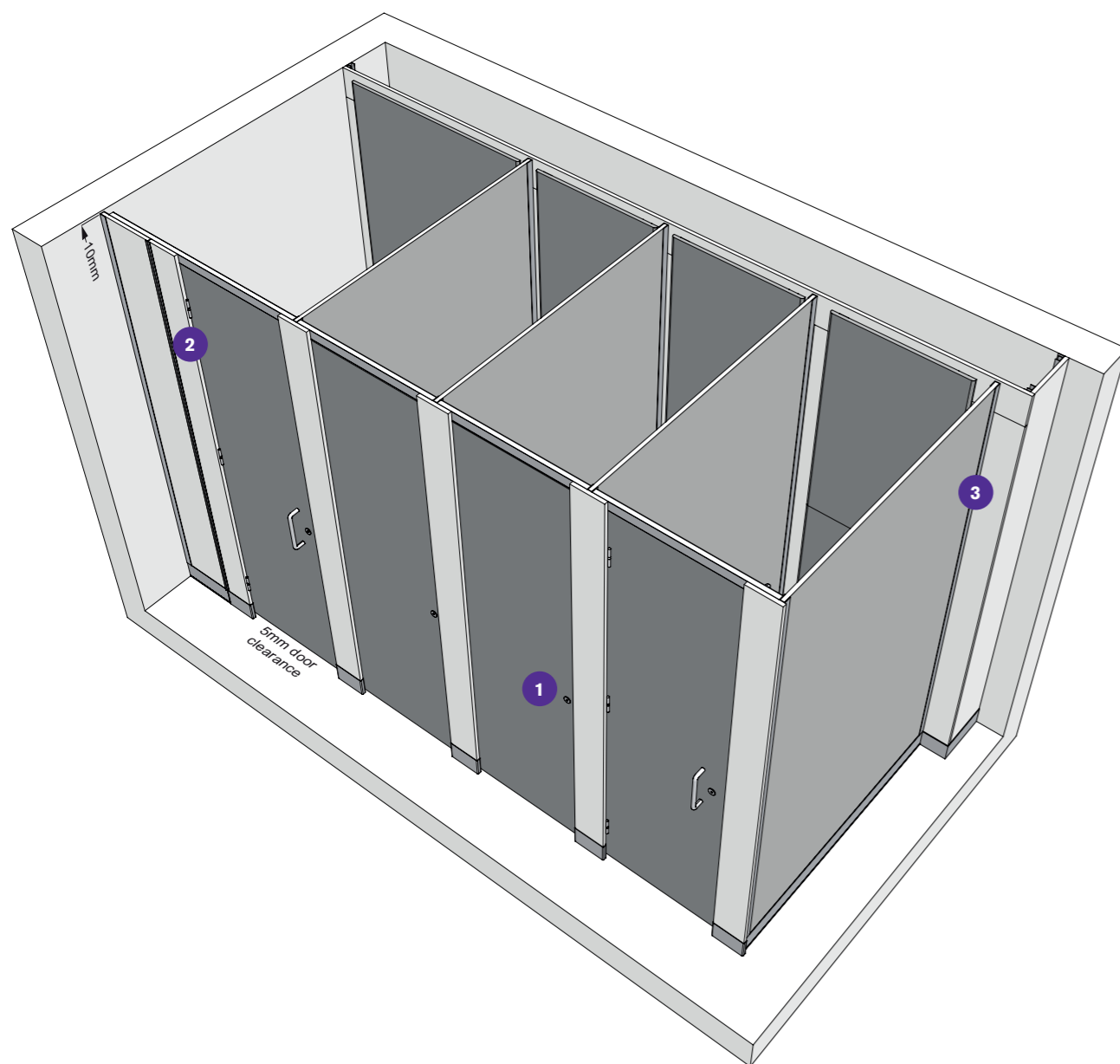

1 Indicator bolt



1 Indicator bolt



1 Keep



2 Hinge



3 U-channel

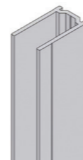

Dimensions

| | |
|-----------------------|--------|
| Maximum height | |
| MFC | 2790mm |
| HPL | 2790mm |
| SGL | 2790mm |

| | |
|----------------------|--------|
| Maximum depth | |
| MFC | 2019mm |
| HPL | 2019mm |
| SGL | 1921mm |

| | |
|---------------------------------|--|
| Floor clearance | |
| 5mm at doors | |
| 0mm at partitions and pilasters | |

| | |
|----------------------------------|--|
| Minimum ceiling clearance | |
| 10mm | |

Performance

Available in three material options, Titan is suitable for every type of wet or dry environment, allowing you to specify the most appropriate option to meet the site requirements and your budget.

MFC

For dry environments with low risk of vandalism. Panels are manufactured from 19mm nominal thickness high performance moisture-resistant melamine faced chipboard. Edges lipped with ABS.

HPL

For more heavily used washrooms, panels are heat, scratch and impact resistant. Manufactured from moisture-resistant chipboard faced with high pressure laminate, panels are 19mm nominal thickness. Edges lipped with ABS.

SGL

Solid grade laminate is extremely resistant to impact and all surfaces are impervious to water. Panels are 13mm nominal thickness with polished black radiused edges.

Detailing

Panels and doors

Available in MFC, HPL and SGL.

Colour finish

MFC, HPL and SGL

34 colours from the standard range.

Cubicle hardware

Satin anodised aluminium.

Edge treatment

MFC and HPL

Matching ABS lipping.

SGL

Polished black radiused edge.

Headrail

Easy to fix, one piece construction high strength extruded satin anodised aluminium L-angle headrail.

Cubicle hardware

Indicator bolt

Satin anodised aluminium slide operated bolt with circular faceplate and emergency release facility. Faceplate and keep with concealed fixings.

Hinge

Satin anodised aluminium rise and fall anti-finger trap hinge. Outward opening hinge option available.

Pedestal

Unique satin anodised aluminium shoe.

Fixings

Partition to floor: Unique satin anodised aluminium skirting channel with height and appearance matching pilaster shoe.

Partition to wall: Satin anodised aluminium U-channel.

Pilaster to partition: Satin anodised aluminium U-channel.

Pilaster to wall: Satin anodised aluminium U-channel.

Accessories

Coat hooks and toilet roll holders available.



Award

Versatile, economical and easy to assemble, Award gives you a tried and tested bespoke solution that works equally well in wet or dry environments. Plus, it comes in our complete range of vibrant colours and a choice of sleek fittings.



01 Pedestals are set back on partitions for a floating appearance.

02 Satin anodised aluminium indicator bolt faceplate.

See p60-61 for Award technical specifications.

Main image

Award HPL cubicles in Suede and Olive with satin anodised aluminium fittings. Vepps panelling in Olive and Suede with Langley wall hung WCs, Marden Waterless urinals and Electroflo urinal sensors.

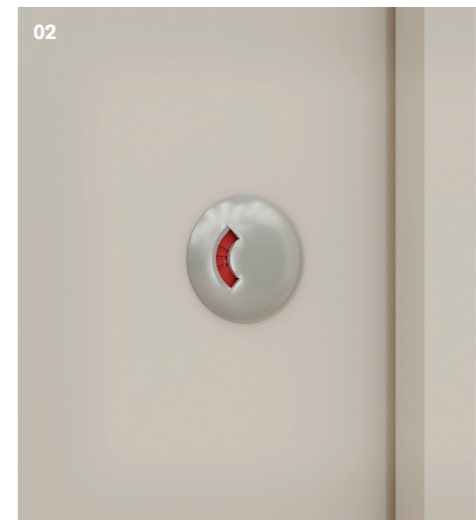

Key features

- Simple installation
- Easy grip indicator bolts with emergency release facility
- Anti-finger trap hinges as standard
- Economical
- Suitable for dry and wet environments with shower curtain track option available
- A choice of 34 on-trend finishes for total design flexibility

Case Study Wimbledon Chase Primary School

Versatile and robust Award toilet cubicles were specified due to the unrivalled safety features that come as standard.

Rated 'Outstanding' by Ofsted since 2012, Wimbledon Chase Primary School teaches over 700 pupils aged 3-11. It offers an inclusive environment where individuality and diversity is celebrated and kindness and respect is instilled in every child.

The school's washroom facilities were in need of a complete overhaul. Accredited Installers, G Haslehurst Builders, were appointed to reconfigure the space which included the installation of contemporary, reliable and easy to maintain washroom systems, all in good time.

Versatile and robust Award toilet cubicles were specified due to the unrivalled safety features that come as standard. Anti-tamper fixings and emergency release indicator bolts make Award a popular choice for schools. These cubicles will stand the test of time thanks to the heat, scratch, impact and water resistant Solid Grade Laminate (SGL) coreboard material specified.

A fun, colourful washroom has been created by specifying the cubicle doors in 'Golden', 'Lime', Rouge' and 'Pacific', while contrasting 'Gunmetal' pilasters and partitions complement the modern décor of the room perfectly.

Read the full case study at www.venesta.co.uk



Technical Specifying Award

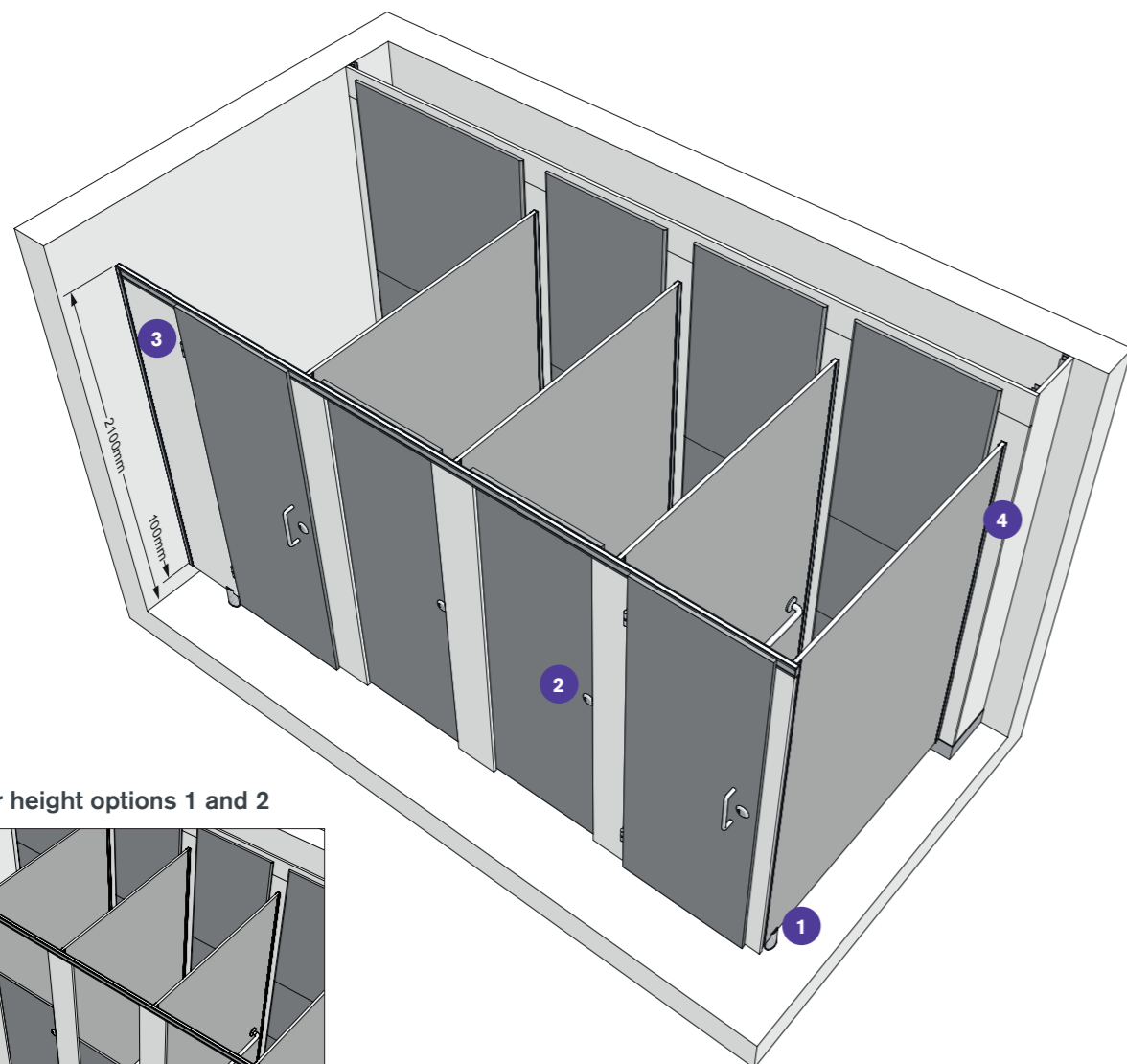

Children's door height options 1 and 2

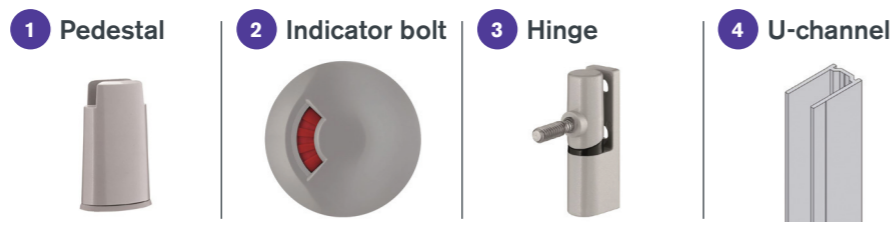
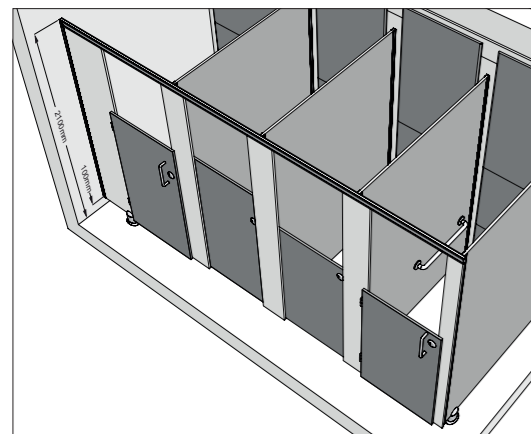

Dimensions

Overall height
2100mm

Door height options

| | |
|---------------------|--------|
| Standard | 2000mm |
| Children's option 1 | 1300mm |
| Children's option 2 | 1100mm |

Maximum depth

| | |
|-----|--------|
| MFC | 2097mm |
| HPL | 2057mm |
| SGL | 1921mm |

Floor clearance
100mm

Performance

Available in three material options, Award is suitable for every type of wet or dry environment, allowing you to specify the most appropriate option to meet site requirements and your budget.

MFC

For dry environments with low risk of vandalism. Panels are manufactured from 19mm nominal thickness high performance moisture-resistant melamine faced chipboard. Edges lipped with ABS.

HPL

For more heavily used washrooms, panels are heat, scratch and impact resistant. Manufactured from moisture-resistant chipboard faced with high pressure laminate, panels are 19mm nominal thickness. Edges lipped with ABS.

SGL

Solid grade laminate is extremely resistant to impact and all surfaces are impervious to water. Panels are 13mm nominal thickness with polished black radiused edges.

Detailing

Panels and doors

Available in MFC, HPL and SGL.

Colour finish

MFC, HPL and SGL

34 colours from the standard range.

Cubicle hardware

Light Grey ABS, satin anodised aluminium or satin anodised effect powder coated zinc.

Edge treatment

MFC and HPL

Matching ABS lipping.

SGL

Polished black radiused edge.

Headrail

Rigid satin anodised aluminium headrail with matching end cap.

Cubicle hardware

Indicator bolt

Easy grip sliding bolt with emergency release facility and concealed fixings. Available in satin anodised effect powder coated zinc or Light Grey ABS.

Hinge

Anti-finger trap satin anodised aluminium rise and fall butt hinge. Outward opening hinge option available.

Pedestal

Height adjustable for uneven floors, with concealed fixings, available in Light Grey ABS or satin anodised effect powder coated zinc. Where possible, pedestals are located on partitions to give a floating appearance.

Fixings

Partition to wall: Continuous satin anodised aluminium U-channel.
Pilaster to partition: Continuous satin anodised aluminium U-channel.
Pilaster to wall: Continuous satin anodised aluminium U-channel.

Accessories

Coat hooks and toilet roll holders available.

We know panelling.

At Venesta, we're renowned for our innovations in panelling. From our Venesta Engineered Pre-Plumbed System, Vepps, to our cost-effective Rapiduct system, we have a fit for purpose solution to suit your needs.

Panelling

You're assured of the right solution.
 We know that every design scheme is different, so we've created three different solutions, each one carefully designed and manufactured with you in mind. Whether you need a made to measure, ready to install integrated system, or a basic, excellent value alternative, you can find it here.

Vepps

Pre-plumbed

With over 120 years of washroom innovation, we introduce Vepps. Our revolutionary, fully engineered metal framed pre-plumbed system offers even faster installation, even easier ongoing maintenance and a much wider range of factory fitted sanitaryware, all at a lower cost. What makes Vepps unique is its linear-bearing hinges and support ratchets, offering easy access to duct space and effortless, smooth movement. A Venesta dowel dock ensures perfect panel alignment whilst zinc plated steel tie backs offer improved stability to the whole system. Vepps can be specified with any Venesta cubicle or vanity system. Plus it of course comes with Venesta's rock solid 10 year product guarantee.



Frameduct

Non-plumbed

If you're looking for a sturdy, metal-framed panelling system but want the choice of specifying your own sanitaryware, then Frameduct is the ideal solution. It's made to measure and features a click-fix mechanism so it's quick and easy to install. Frameduct can be specified with any Venesta cubicle or vanity system.



Rapiduct

Timber-framed

Simple, functional and cost-effective, this panelling system is flexible enough to suit any cubicle range. Unlike the other panelling options, Rapiduct is constructed onto a timber-frame, not supplied by Venesta, and is designed for your own build and installation. You can specify Rapiduct with any Venesta cubicle or vanity system.



| Benefits | Vepps | Frameduct | Rapiduct |
|--|-------|-----------|----------|
| Factory fitted sanitaryware | • | | |
| Choice of pre-plumbed WC suites, urinals, basins and vanity units | • | | |
| Fully tested sanitaryware | • | | |
| Speedy installation | • | • | • |
| Factory assembled guaranteeing a quality product and finish | • | • | |
| Unique click-fix metal frame | • | • | |
| Metal framework, impervious to water | • | • | |
| Product longevity | • | • | • |
| Suitable for use with all types of sanitaryware | | • | • |
| Lockable duct panel option | • | • | • |
| Conceals plumbing and services (wastes and traps) | • | • | • |
| Provides easy access for maintenance | • | • | • |
| Choice of board types and edge details providing an offering to suit any application | • | • | • |
| Universal - it complements any cubicle range | • | • | • |
| 10-year product guarantee | • | • | • |
| Venesta linear-bearing hinge and panel support ratchets for easy maintenance | • | • | |

Making specifying panelling easy.

Venesta has a proven track record of supplying high quality panelling systems to the UK's most demanding education environments. From our Venesta Engineered Pre-Plumbed System, Vepps, to our cost-effective Rapiduct system, we have a fit for purpose solution to suit your needs.



You need simplicity.
Vepps is the industry's first precision engineered pre-plumbed panelling system with a click-fix assembly into an aluminium frame. That means installation is efficient and cost-effective.

- Key features**
- Metal-framed, pre-plumbed system
 - Factory fitted sanitaryware
 - Ultra strong aluminium frame
 - Industry leading design
 - Unique Venesta linear-bearing hinge™
 - Complete onsite flexibility
 - Provides a cost-effective, quick installation
 - Reduces the need for onsite specialist skills
 - Suitable for wet and dry environments
 - Bespoke system ready to install
 - Suitable for all board types
 - Increased product longevity



With 7 unbeatable benefits...

Cost.
 Proven to be more cost effective over the whole project lifecycle.

Onsite speed.
 Onsite installation 50% faster than traditional plain panel method systems.

Quality.
 Perfect factory finish and panel alignment as well as a 10-year guarantee.

Maintenance.
 No manual handling with our linear-bearing hinged panels.

Health & Safety.
 Less tradesmen and less time spent on site reduces health and safety risk.

Choice.
 Sanitaryware from Ideal Standard, Armitage Shanks and SanCeram.

Environment.
 90% less packaging and board waste is recycled in our biomass burner.

Main image
 Cenrution Full Height cubicles in Gunmetal and Vepps shelf height pre-plumbed panelling in Golden.

Panelling

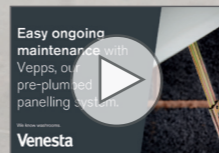

See how quick and easy it is to operate Vepps by watching the dedicated video on our YouTube channel.

You need speedy installation.

Our design team created Vepps to ensure that's what you get. There are four easy steps to installation so you can be up and running in the shortest possible time frame, with a guaranteed quality finish.



01 Once the site has been prepared, fix the aluminium docking frame to the wall, ceiling and floor.

25 minute installation



02 Click-fix the first Vepps unit onto the frame and slide into position. Open the mid panel to a fully hinged position. Attach a vertical flashgap to the frame on either side of the unit, screw-fixing to the frame from the face. Fix tie back to the wall. Repeat until all units are in place.

30 minute installation



03 Once all the units are in position, connect the plumbing and services.

10 minute installation*



04 Simply close the hinged panel and attach the top and bottom panels of the unit. Installation complete.

5 minute installation

The comparisons given between Vepps, Frameduct and Rapiduct are a guide and are designed to help you choose the right product for your project. * Dependent on brassware.

Vepps Sanitaryware, brassware and fittings



Contour 21+ back to wall rimless WC
S0439HY 410mm height



Contour 21+ raised height back to wall rimless WC
S0440HY



Sandringham 21 back to wall WC
E897401



Sandringham 21 wall hung WC*
V391001
Requires Vepps WC Carrier



Jasper Morrison 550mm semi-recessed basin*
E620601 1 tap hole



Concept 450mm semi-recessed basin
E797901 1 tap hole



Profile 21 500mm semi-recessed basin
S249201 1 tap hole



Profile 21 500mm semi-recessed basin
S249401 2 tap holes



Contour 21+ wall hung rimless WC
S0443HY
Requires Vepps WC Carrier



Contour 21+ rimless back to wall WC
S0437HY 700mm projection
S0438HY 750mm projection



Contour 21 schools 305 back to wall WC
S304601 305mm height
S304701 355mm height



Contour hygieniq rimless urinal bowl
S611901 675mm height



Sandringham 21 500mm semi-recessed basin*
E895801 1 tap hole



Sandringham 21 500mm semi-recessed basin
E895901 2 tap holes



Contour 21 370mm panel mounted basin
S212201 Centre tap hole



Contour 21 370mm panel mounted basin
S247301 Left tap hole



Contour urinal bowl
S611001 665mm height



Sanura urinal bowl*
S610001 500mm height



Urinal division with hanger and screw
S612001 675mm height



Concept 430mm vessel basin*
E803901 1 tap hole



Contour 21 370mm panel mounted basin
S247401 Right tap hole



Sensorflow 21 compact mixer deck mounted tap
A4852AA Mains
A4853AA Link



Sensorflow 21 electronic spout tap
A4171AA Mains
A4172AA Link



Contour 21 thermostatic sequential basin mixer tap
A4131AA Flexi tails
A4169AA Copper tails



Sandringham 21 500mm countertop basin
E895201 1 tap hole



Sandringham 21 500mm countertop basin*
E895401 2 tap holes



Orbit 21 550mm fully inset basin
S248601 1 tap hole



Orbit 21 550mm fully inset basin*
S248801 2 tap holes

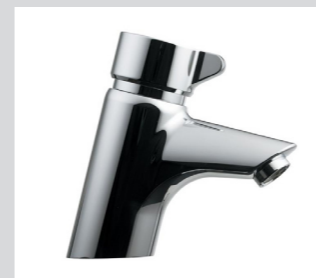

Avon 21 push button self closing mixer tap
B8263AA Flexi tails
B8861AA Copper tails



Avon push button self closing bib tap*
S7241AA



Sensorflow 21 compact wall spout 230mm
A4849AA Mains*
A4850AA Link*



Avon 21 push button self closing pillar taps
B8267AA Pair

Vepps Sanitaryware, brassware and fittings



Sandringham SL 21 basin pillar taps*
B3304AA Pair



Sandringham 21 self closing pillar taps
S0672AA Pair



Sandringham 21 lever pillar taps*
B9881AA Pair



Sensorflow 21 WC flush
S358967 6 litre flush
S359967 4 or 4.5 litre flush



Sensorflow 21 urinal flush
A7002AA High pressure link
A7001AA High pressure mains
A7059AA Low pressure link*
A7058AA Low pressure mains*



Armitage Shanks unbranded dual flush plate
S4399AA Chrome plated
S4504MY Stainless steel



Pneumatic panel mounted palm push button
S4513MY Stainless steel

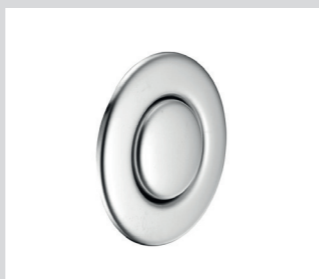

Pneumatic panel mounted finger push button
S4512MY Stainless steel

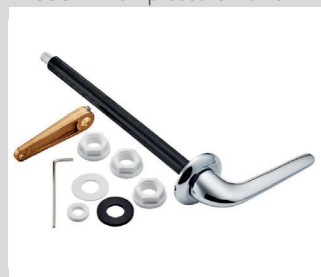

Conceala 2 250mm extended WC lever*
S4491AA



Concentric control thermostatic shower in a box*
S6933MY



Sensorflow 21 electronic shower valve and sensor*
A4185AA Mains
A4186AA Link



Armaglide 2 shower kit
B9306AA



Avon 21 built-in self closing non-mixing shower*
B8266AA Chrome plated



Anti vandal fixed shower head*
A5452AA



Contour 21 built-in sequential shower mixer extended lever
A4129AA



Doc M shower room pack*
S6960AC White
S6960LI Blue
S6960LJ Grey
S6960RN Charcoal
S6960MY Stainless Steel



Doc M Contour 21+ back to wall left or right hand packs
S0685AC White - Left hand pack
S0686AC White - Right hand pack



Doc M Contour 21+ back to wall left or right hand packs
S0685LI Blue - Left hand pack
S0686LI Blue - Right hand pack



Doc M Contour 21+ back to wall left or right hand packs
S0685LJ Grey - Left hand pack
S0686LJ Grey - Right hand pack



Doc M Contour 21+ back to wall left or right hand packs
S0685MY Stainless steel - Left hand pack*
S0686MY Stainless steel - Right hand pack*



Doc M Contour 21+ back to wall left or right hand packs
S0685RN Charcoal - Left hand pack
S0686RN Charcoal - Right hand pack



Doc M Contour 21+ back to wall left or right hand packs
S0685GQ Red - Left hand pack*
S0686GQ Red - Right hand pack*

*Could incur extended lead times, please contact our friendly sales team for further information

Vepps Sanitaryware, brassware and fittings



Langley back to wall rimless WC
LLWC102



Langley Curve back to wall rimless WC
LLWC122



Chartham Beyond back to wall rimless WC
CHWC121



Chartham back to wall WC
CHWC102



Langley concealed trap urinal
LLUR101



Marden concealed trap urinal
MDUR101



Chartham exposed trap urinal
CHUR104



Marden waterless urinal
MDUR103



Chartham rimless 450mm back to wall WC
CHWC103



Chartham rimless 480mm back to wall WC
CHWC104



Langley wall hung rimless WC
LLWC101
Requires Vepps WC Carrier



Langley Curve wall hung WC
LLWC121
Requires Vepps WC Carrier



Langley waterless urinal
LLUR104



Urinal separator
CHUR107



Chartham 530mm countertop basin
CHWB112 Centre tap hole



Langley 400mm under counter basin
LLWB107 No tap hole



Chartham wall hung WC
CHWC101
Requires Vepps WC Carrier



Chartham Beyond wall hung rimless WC
CHWC122
Requires Vepps WC Carrier



Chartham rimless back to wall 700mm projection
CHWC105



Marden 560mm under counter basin
MDWB107 No tap hole



Shenley 500mm countertop basin
SHWB103 Centre tap hole
SHWB104 2 tap holes



Langley semi-recessed basin 500mm
LLWB104 Centre tap hole



Marden semi-recessed basin 520mm
MDWB105 Centre tap hole



Chartham rimless back to wall 750mm projection
CHWC106



Shenley back to wall 350mm WC
SHWC101



Chartham wall hung 700mm projection WC
CHWC117
Requires Vepps WC Carrier



Chartham semi-recessed basin 450mm
CHWB109 Right tap hole



Chartham semi-recessed basin 450
CHWB108 2 tap holes



Shenley slim semi-recessed basin 400mm
SHWB105 Right tap hole



Marden square semi-recessed basin 460mm
MDWB113 Centre tap hole

Vepps Sanitaryware, brassware and fittings



Langley 400mm wall hung basin
LLWB101 Centre tap hole



Marden 525mm wall mounted basin
MDWB103 Centre tap hole



Marden 420mm wall mounted basin
MDWB101 Centre tap hole



Chartham wall hung 450mm basin
CHWB104 Centre tap hole



Chartham wall hung 450mm basin
CHWB103 2 tap holes



Chartham wall hung 380mm basin
CHWB101 Left tap hole



Chartham wall hung 380mm basin
CHWB102 Right tap hole



Chartham wall hung 500mm basin
CHWB105 Right tap hole



Marden square 460mm basin
MDWB111 Central tap hole



Langley round vessel basin
LLWB122 No tap hole



Langley oval vessel basin
LLWB123 No tap hole



Langley rectangular vessel basin
LLWB121 No tap hole



SanCeram sequential TMV3 mixer tap
SCBW120 Flexi tails
SCBW115 Copper tail pack



SanCeram basin mounted self-closing mixer tap
SCBW106



Vision non convulsive self closing mixer tap*
VSN123



Insignia lever mixer tap
INS113



Swoop MK2 lever mixer tap
SWO2113



Swoop MK2 tall lever mixer tap
SWO2113EX



Hartley mixer tap*
HABW101 Chrome



Hartley mixer tap*
HABW101N Brushed nickel



Hartley mixer tap*
HABW101B Matt black



Hartley tall mixer tap*
HABW102 Chrome



Hartley tall mixer tap*
HABW102N Brushed nickel



Hartley tall mixer tap*
HABW102B Matt black



Hartley wall mounted mixer tap*
HABW103 Chrome



Hartley wall mounted mixer tap*
HABW103N Brushed nickel



Hartley wall mounted mixer tap*
HABW103B Matt black



Adore mini basin mixer tap
ADORE313

*Could incur extended lead times, please contact our friendly sales team for further information

Vepps Sanitaryware, brassware and fittings



Insignia lever pillar taps
INS101 Pair



Short lever taps
DLT101 Pair



Press action taps
NCT001 Pair

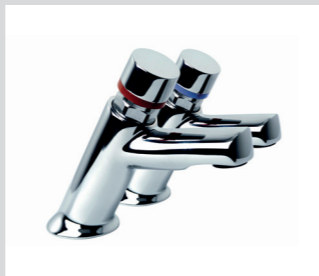

Contemporary press action taps
SCBW124 Pair

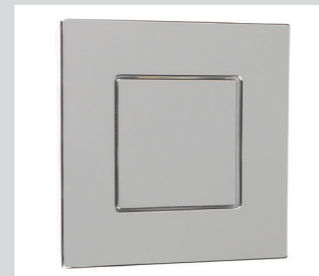

Concealed single flush cistern with square button
CIST103

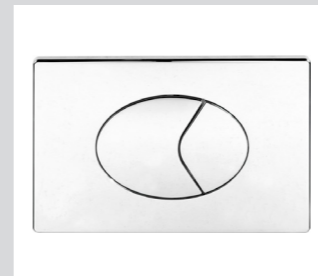

Concealed dual flush cistern with oyster push button
CIST107



Concealed single flush cistern with palm push button
CIST105



Concealed single flush cistern with vandal resistant button
CIST106



Aquarius A45 sensor tap*
AT03011



SanCeram deck mounted sensor tap
SCBW119
SCBW116 Mains transformer



Deva sensor tap
SENSOR1D



Deva deck mounted temperature adjustment sensor tap
SENSOR6BT



Concealed dual flush cistern with lever
CIST101



Concealed dual flush cistern with dimple lever
CIST102



Sequential lever operated concealed shower valve
SHWR112



Deva Vision thermostatic concealed shower valve
VSNVSEQ02



Deva tall sensor tap*
SENSOR3D



Deva wall mounted sensor tap*
SENSOR9W



Aquarius wall mounted 150mm sensor tap spout
AT02001



Deva lever action bib taps
DLT095 Pair

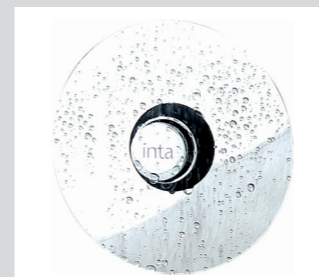

Self-closing concealed shower valve
SHWR122



SanCeram anti-vandal short projection shower head
SHWR124



Deva 6" lever handles
DLV002 Pair



Concealed WC flush sensor
CIST108 Single (battery)
CIST109 Dual (battery)
CIST110 Mains transformer



Electroflo urinal sensor
URIN108 Battery
URIN109 Mains



Concealed dual flush cistern with square button
CIST104



SanCeram anti-ligature fixed shower head
SHWR118

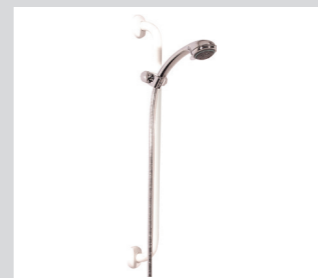

SanCeram grab rail based shower kit
SHWR115 White



SanCeram back to wall WC Doc M pack

Left hand pack
SCDMBTWLW White
SCDMBTWLB Blue
SCDMBTWLG Grey
SCDMBTWLSS Stainless steel

Right hand pack
SCDMBTWRW White
SCDMBTWRB Blue
SCDMBTWRG Grey
SCDMBTWRSS Stainless steel

*Could incur extended lead times, please contact our friendly sales team for further information

Case Study Magdalen College School

Our industry leading Vepps pre-plumbed panelling system meant that installation was quick and straightforward.

Magdalen College School (MCS), based in the heart of Oxford, is a friendly, inclusive and highly distinctive school of 900 pupils, aged 7-18 and is now one of the country's leading schools.

The project to renovate the washrooms at Magdalen College School was part of the estate's recent refurbishment programme by Grey Baynes and Shew Architects. MCS wanted a washroom renovation that captured the essence of the school by using a simple, yet striking design.

Our Vepps (IPS) pre-plumbed panelling system was installed at Magdalen College School, which meant installation was quick and straightforward. The Ideal Standard sanitaryware was pre-plumbed and tested in our factory, so that installation was completed in just four easy steps, reducing the need for specialist onsite skills. High strength, linear-bearing hinges means maintenance of the washroom facilities couldn't be simpler.

With clean, modern lines and a "floating" flush front, Venesta's Unity cubicle range was the perfect choice for MCS. A full height cubicle range with sleek fittings and set back pedestals, Unity provides a seamless, durable washroom environment, with a low floor clearance for privacy. With discreet emergency release mechanism indicator bolts, the range is an ideal choice for education environments, where safety is paramount.

Thanks to its waterproof, dense and robust properties, Solid Grade Laminate (SGL) was selected as the material used for the Unity cubicles and Vepps panelling; the ideal choice for a heavy use area such as this that required regular cleaning.

Read the full case study at www.venesta.co.uk

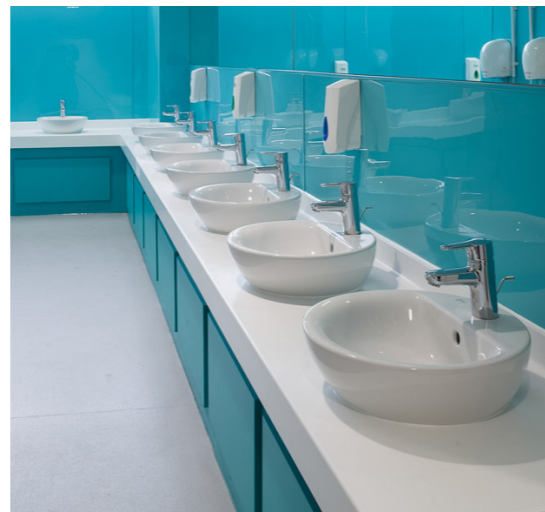

Technical Specifying Vepps

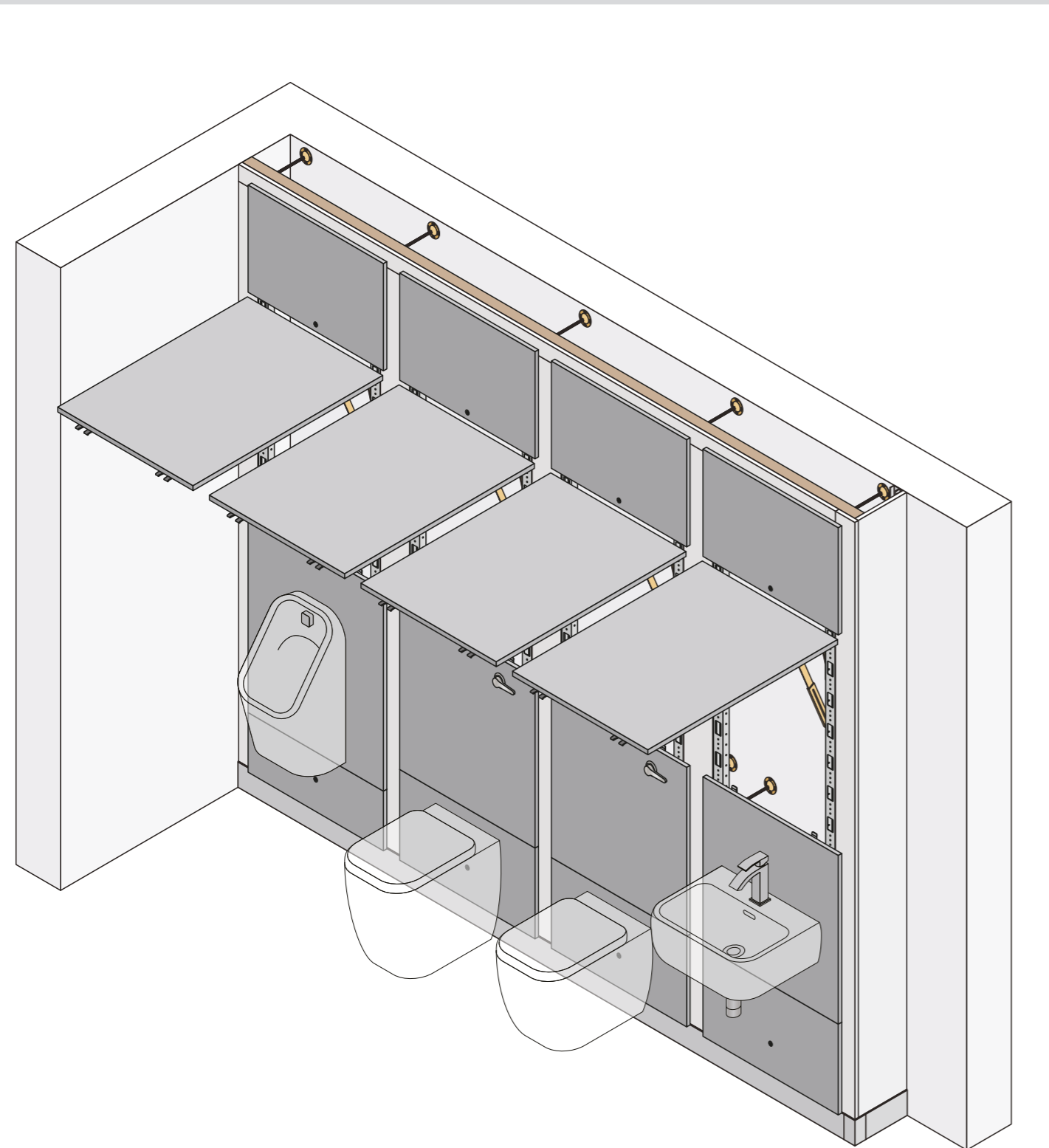

Dimensions

Maximum ceiling height*

| | |
|------------|--------|
| MFC | 3000mm |
| HPL | 3000mm |
| SGL | 3000mm |

*Maximum heights subject to change with woodgrain colours.

Bespoke heights available.

Skirting/baserail height

100mm

Top flashgap

50mm minimum

Hinged panels

Hinged and lockable panels available up to 850mm width.

Sanitaryware



Fitted sanitaryware has been specially engineered to give you the highest quality finish.

WCs

Basins

Urinals

Showers

Baths

Squat pans

Cleaners sinks

Sanitaryware

Performance

Available in six material options, Vepps is suitable for every type of wet or dry environment, allowing you to specify the most appropriate panel option to meet the site requirements and your budget.

MFC

For dry environments with low risk of vandalism. Panels are manufactured from 19mm nominal thickness high performance moisture-resistant melamine faced chipboard. Edges lipped with ABS.

HPL

For more heavily used washrooms, panels are heat, scratch and impact resistant. Manufactured from moisture-resistant chipboard faced with high pressure laminate, panels are 19mm nominal thickness. Edges lipped with ABS. Post-formed vertical edge option available.

SGL

Solid grade laminate is extremely resistant to impact and all surfaces are impervious to water. Panels are 13mm nominal thickness with polished black radiused edges.

ColourCoat

Panels are 18mm nominal thickness MDF sprayed with a coat of primer and finished with 20% gloss pigmented lacquer.

ColourCoat High Gloss

Panels are 18mm nominal thickness MDF sprayed with a coat of primer and finished with 80% gloss pigmented lacquer.

Veneer

Manufactured from moisture resistant chipboard faced with real wood veneer, panels are 18mm nominal thickness. Edges lipped with matching ABS lipping.

Detailing

Panels

Available in MFC, HPL, SGL, ColourCoat, ColourCoat High Gloss and Veneer.

Flashgaps

MFC, SGL, ColourCoat, ColourCoat High Gloss and Veneer.

Colour finish

MFC, HPL and SGL
34 colours.

ColourCoat & ColourCoat High Gloss
10 ColourCoat and ColourCoat High Gloss colours available when specifying Vepps with selected V1 and V2 cubicle ranges. Unlimited ColourCoat and ColourCoat High Gloss options (any classic RAL) when specifying Vepps with selected V3 cubicle ranges.

Veneer

Wide range of Alpi veneer options (varying price points).

Edge treatment

MFC and HPL

Matching ABS lipping.

Post-formed vertical edge option available with HPL.

SGL

Polished black radiused edge.

ColourCoat & ColourCoat High Gloss

Edges are sprayed with a coat of primer and finished with 20% or 80% gloss pigmented lacquer, respectively.

Veneer

ABS lipping to match.

Flashgaps

Flashgaps have unfinished edges except return end flashgaps which will be ABS lipped (or polished if solid grade laminate).

Docking frame

Headrail and baserail manufactured from extruded aluminium section.

Subframes

Manufactured from rolled galvanised steel section with aluminium cross brace bars. Subframe installed within aluminium docking frame by click-fix nylon location brackets. Back panels fixed to steel section by metal brackets.

90° linear-bearing hinge™

Manufactured from zinc plated steel with chrome plated rivets and black glass filled nylon linear-bearing, set at fixed height of 1950mm.

Panel lock

Manufactured from stainless steel with a polished finish in set positions.

Technical Specifying Vepps

WC Hinged Panels

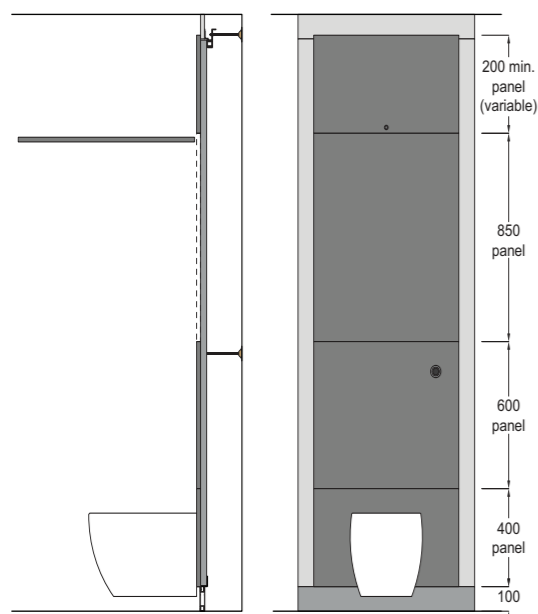

Washbasin Hinged Panels

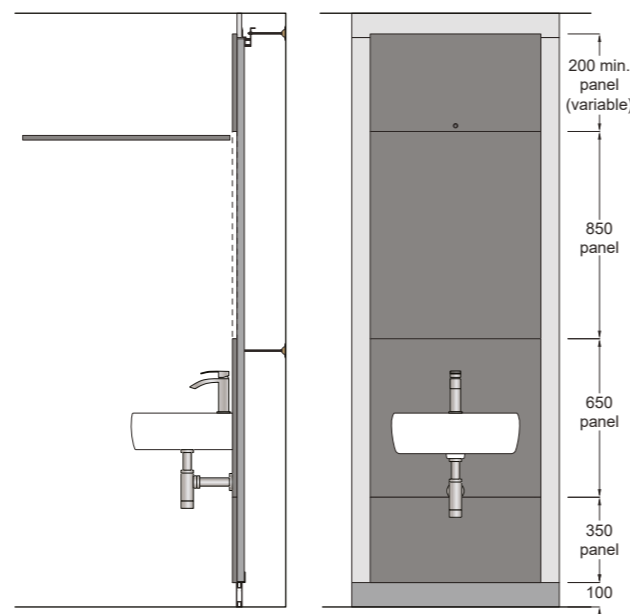

Urinal Hinged Panels

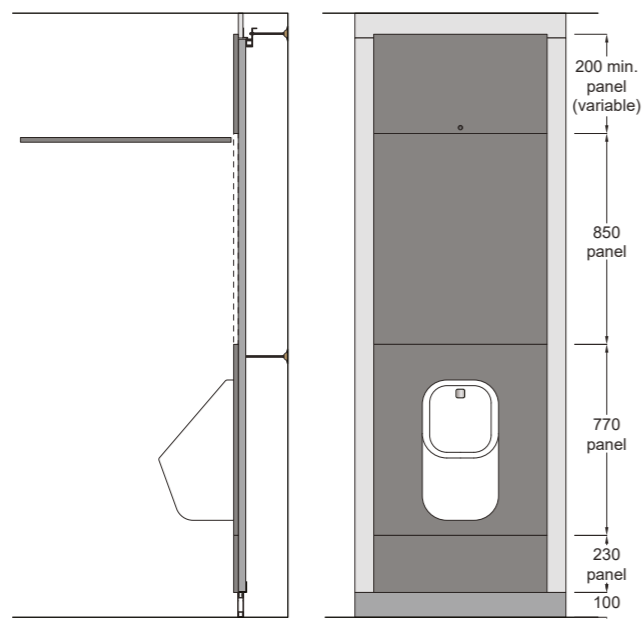

Secrets of Vepps

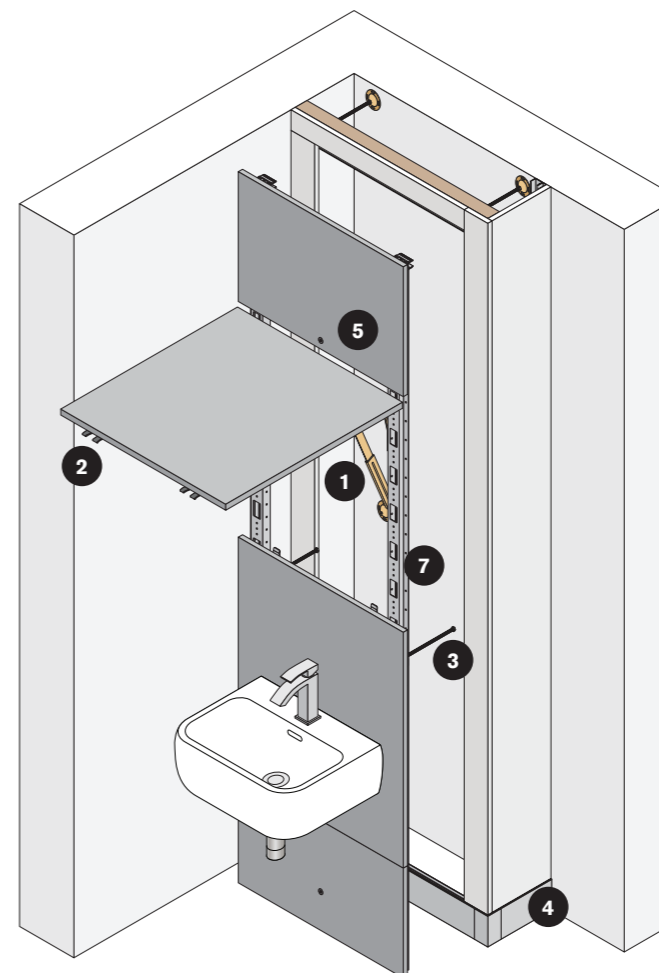

1. Venesta linear-bearing hinge™
Our precision engineered, high strength linear-bearing hinges and panel support ratchets offer smooth movement and allow panels to be positioned at 10 different heights, all without any gaps between panels. Patent approved.

2. Venesta dowel-dock
Designed for strength and perfect panel alignment, our dowel-dock system ensures panels return to their correct position every time. Patent approved.

3. Tie backs
Adjustable zinc plated steel tie backs offer a bracing system for improved stability and allow for easier, speedier installation.

4. Baserail
Designed in a smooth, modern Light Grey or Dark Grey powder coated aluminium finish, the Vepps baserail, ensures compatibility with all cubicle ranges and washroom designs.

5. Panel lock
We understand the need for added safety without compromised aesthetics. In stainless steel with a tamper proof security key opening, our panel locks are discreet and ensure maximum security.

6. Wall hung WC carrier
Our wall hung WC carrier is made from Solid Grade Laminate. It simply locates into the baserail and is fixed back to the building structure without the need for floor bolts. The assembly has been load tested to 400kg and complies with BSEN 997.

7. Fittings
We understand the need for products that last. That's why all of our metal components are non-ferrous or coated to protect against rusting and corrosion.

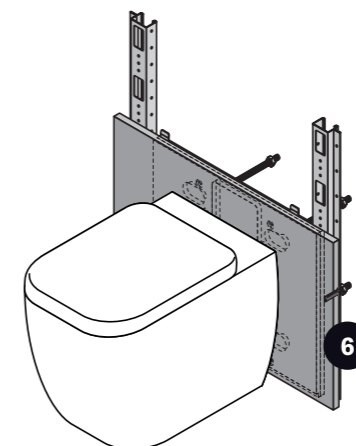

Frameduct Easy installation

Frameduct's superbly crafted, metal-framed panelling has been created to give you quick and easy installation. Its clever click-fix mechanism is simplicity itself. Not only that, Frameduct gives you the opportunity to choose your own sanitaryware.



01 Once the site has been prepared, fix the aluminium docking frame to the wall, ceiling and floor.

20 minute installation



02 Click-fix the first Frameduct unit onto the frame and slide into position. Open the mid panel to a fully hinged position. Attach a vertical flashgap to the frame on either side of the unit, screw-fixing to the frame from the face. Fix tie back to the wall. Repeat until all units are in place.

30 minute installation



03 Drill or cut out for sanitaryware.

10 minute installation



04 Mount sanitaryware and brassware.

20 minute installation



05 Once all the units are in position, connect the plumbing and services and apply silicone sealant to sanitaryware.

10 minute installation*



06 Simply close the hinged panel and attach the top and bottom panels of the units. Installation is complete.

5 minute installation

You need easy installation.

Frameduct brings you an intelligent, great looking system that's easy to install but with an added bonus - you get to choose your own sanitaryware.

Technical Specifying Frameduct

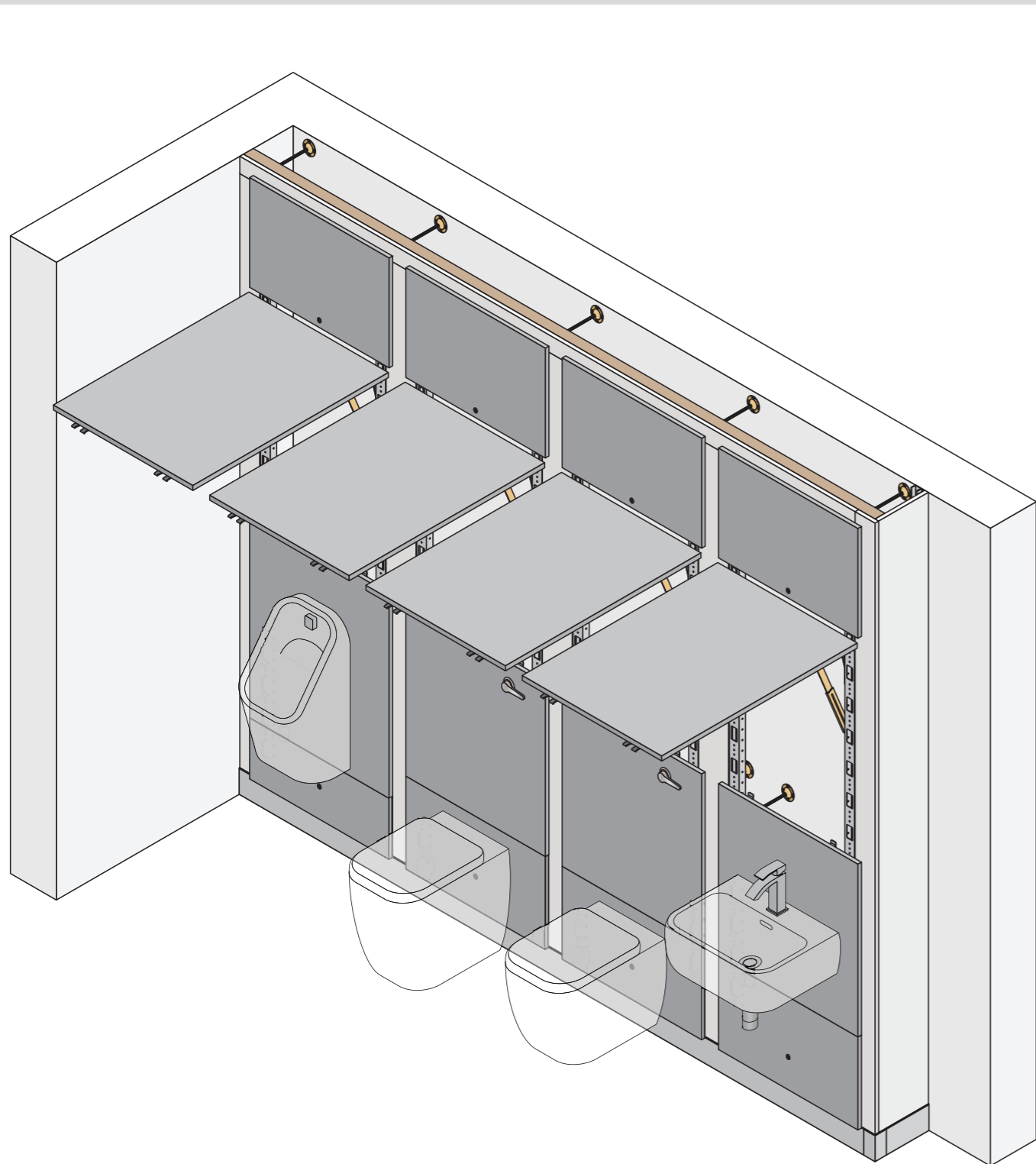

Dimensions

Maximum ceiling height*

| | |
|------------|--------|
| MFC | 3000mm |
| HPL | 3000mm |
| SGL | 3000mm |

*Maximum heights subject to change with woodgrain colours.

Bespoke heights available.

Skirting/baserail height

100mm (other skirting heights achievable by site packing the baserail).

Top flashgap

50mm

Hinged Panels

Hinged and lockable panels available up to 850mm width.

Performance

Available in six material options, Frameduct is suitable for every type of wet or dry environment allowing you to specify the most appropriate panel option to meet the site requirements and your budget.

MFC

For dry environments with low risk of vandalism. Panels are manufactured from 19mm nominal thickness high performance moisture-resistant melamine faced chipboard. Edges lipped with ABS.

HPL

For more heavily used washrooms, panels are heat, scratch and impact resistant. Manufactured from moisture-resistant chipboard faced with high pressure laminate, panels are 19mm nominal thickness. Edges lipped with ABS. Post-formed vertical edge option available.

SGL

Solid grade laminate is extremely resistant to impact and all surfaces are impervious to water. Panels are 13mm nominal thickness with polished black radiused edges.

ColourCoat

Panels are 19mm nominal thickness MDF finished, sprayed with a coat of primer and finished with 20% gloss pigmented lacquer.

ColourCoat High Gloss

Panels are 18mm nominal thickness MDF finished, sprayed with a coat of primer and finished with 80% gloss pigmented lacquer.

Veneer

Manufactured from moisture resistant chipboard faced with real wood veneer, panels are 18mm nominal thickness. Edges lipped with matching ABS lipping.

Detailing

Panels

Available in MFC, HPL, SGL, ColourCoat, ColourCoat High Gloss and Veneer.

Flashgaps

MFC, SGL, ColourCoat, ColourCoat High Gloss and Veneer.

Colour finish

MFC, HPL and SGL
34 colours.

ColourCoat and ColourCoat High Gloss
10 ColourCoat and ColourCoat High Gloss colours available when specifying Frameduct with selected V1 and V2 cubicle ranges. Unlimited ColourCoat and ColourCoat High Gloss options (any classic RAL) when specifying Frameduct with selected V3 cubicle ranges.

Veneer

Wide range of Alpi veneer options (varying price points).

Edge treatment

MFC and HPL
Matching ABS lipping.
Post-formed vertical edge option available with HPL.

SGL

Polished black radiused edge.
ColourCoat and ColourCoat High Gloss
Edges are sprayed with a coat of primer and finished with 20% or 80% gloss pigmented lacquer, respectively.

Veneer

ABS lipping to match.

Flashgaps

Flashgaps have unfinished edges except return end flashgaps which will be ABS lipped (or polished if solid grade laminate).

Docking frame

Headrail and baserail manufactured from extruded aluminium section.

Subframes

Manufactured from rolled galvanised steel section with aluminium cross brace bars. Subframe installed within aluminium docking frame by click-fix nylon location brackets. Back panels fixed to steel section by nylon clips.

90° linear-bearing hinge™

Manufactured from zinc plated steel with chrome plated rivets and black glass filled nylon linear-bearing, set at fixed height of 1950mm.

Panel lock

Manufactured from stainless steel with a polished finish in set positions.

Rapiduct Easy installation

You need easy installation.

Simple, functional and highly cost-effective, this timber-framed panelling system is flexible enough to suit any washroom and is designed for your own installation. You can specify Rapiduct with any Venesta cubicle or vanity system.

The best value for function, finish and easy installation, Rapiduct's clever construction means it can be put together in the shortest time.



01 Install timber-frame (supplied by others).

30 minute installation



02 Fit base flashgaps to the site frame followed by vertical, horizontal and top flashgaps.

20 minute installation



03 Attach fixing clips to the inside edge of the vertical flashgaps, repeat process on back face of panels.

30 minute installation



04 Drill or cut out for sanitaryware.

10 minute installation



05 Mount combined panel, sanitaryware and brassware onto flashgaps before completing pipework.

20 minute installation



06 Once all the units are in position, connect the plumbing and services.

10 minute installation*



07 Simply attach the top and bottom panels to the units. Installation complete.

5 minute installation

The comparisons given between Vepps, Frameduct and Rapiduct are a guide and are designed to help you choose the right product for your project. * Dependent on brassware.

Technical Specifying Rapiduct

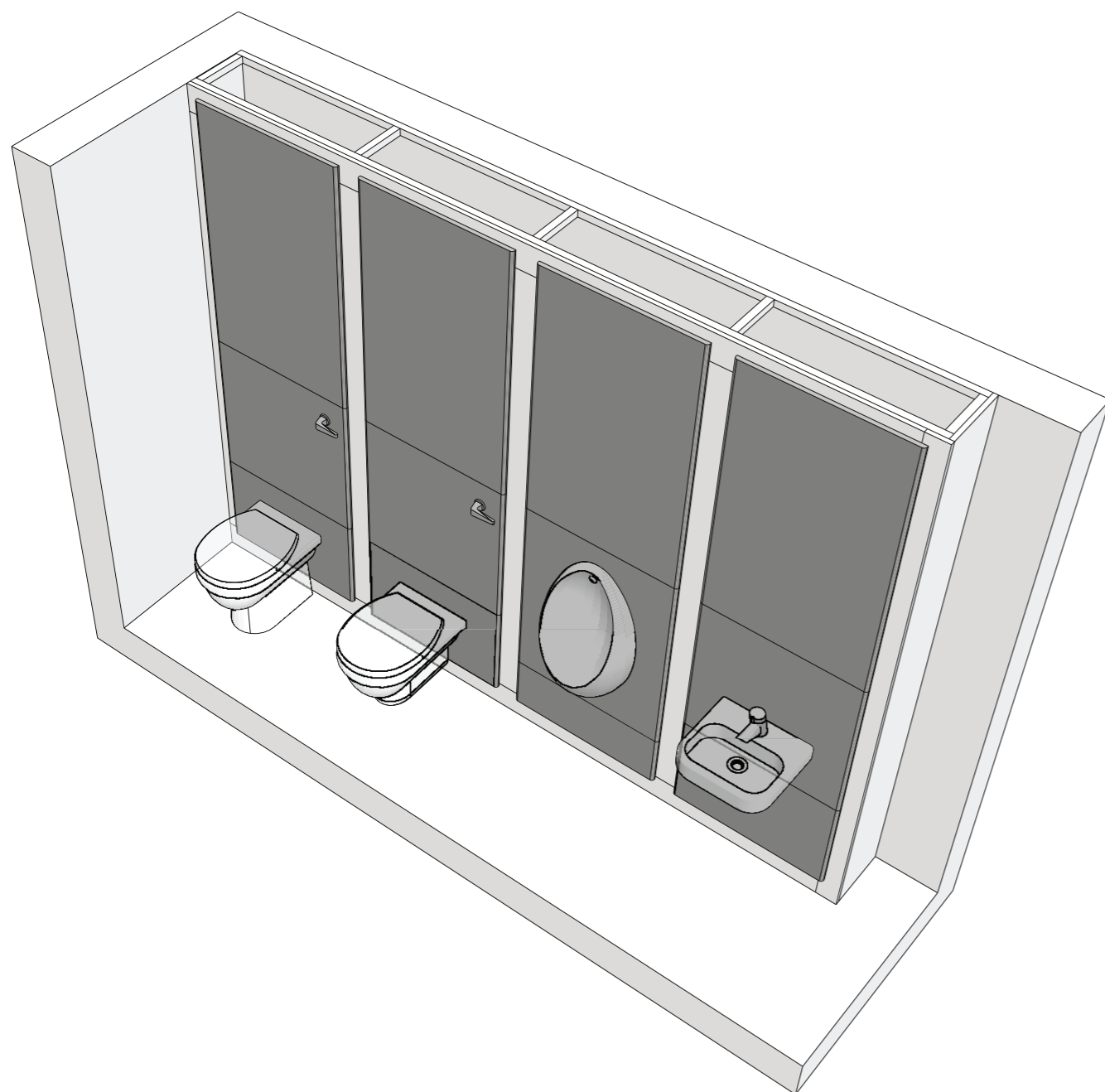

Dimensions

Bespoke panel sizes available to suit site dimensions.

Performance

Available in six material options, Rapiduct is suitable for every type of wet or dry environment, allowing you to specify the most appropriate panel option to meet the site requirements and your budget.

MFC

For dry environments with low risk of vandalism. Panels are manufactured from 19mm nominal thickness high performance moisture-resistant melamine faced chipboard. Edges lipped with ABS.

HPL

For more heavily used washrooms, panels are heat, scratch and impact resistant. Manufactured from moisture-resistant chipboard faced with high pressure laminate, panels are 19mm nominal thickness. Edges lipped with ABS. Post-formed vertical edge option available.

SGL

Solid grade laminate is extremely resistant to impact and all surfaces are impervious to water. Panels are 13mm nominal thickness with polished black radiused edges.

ColourCoat

Panels are 18mm nominal thickness MDF finished, sprayed with a coat of primer and finished with 20% gloss pigmented lacquer.

ColourCoat High Gloss

Panels are 18mm nominal thickness MDF finished, sprayed with a coat of primer and finished with 80% gloss pigmented lacquer.

Veneer

Manufactured from chipboard faced with real wood veneer, panels are 18mm nominal thickness. Edges lipped with matching ABS.

Detailing

Panels

Available in MFC, HPL, SGL, ColourCoat, ColourCoat High Gloss and Veneer.

Flashgaps

MFC, SGL, ColourCoat, ColourCoat High Gloss and Veneer.

Colour finish

MFC, HPL and SGL

34 colours.

ColourCoat and ColourCoat High Gloss

10 ColourCoat and ColourCoat High Gloss options available when specifying Rapiduct with a V2 cubicle range. Unlimited ColourCoat and ColourCoat High Gloss options (any classic RAL) when specifying Rapiduct with a V3 cubicle range.

Veneer

Wide range of Alpi veneer options (varying price points).

Edge treatment

MFC and HPL

All edges are lipped with ABS.

SGL

Polished black radiused edge.

ColourCoat and ColourCoat High Gloss

Edges are sprayed with a coat of primer and finished with 20% or 80% gloss pigmented lacquer, respectively.

Veneer

ABS lipping to match.

Flashgaps

Flashgaps have unfinished edges except return end flashgaps which will be ABS lipped (or polished if solid grade laminate).

Fixing clips

Concealed plastic clips fixed to edge of flashgap strips and reverse of facing panels.

Site frame

Loose flashgaps only supplied by Venesta. Site frame supplied and fixed by site (softwood or similar).

We know washrooms.

To meet your demands, our range of vanities, accessories, lockers and benches bring form and function together in one collection.

Complementary

Vanities Solid Surface

For strength and a smooth, seamless finish, our Solid Surface solution wins hands down. Its stone appearance creates a visually stunning yet highly durable solution which ensures complete impact and thermal shock resistance.



Vanities SGL

The most demanding washroom environments need durable and hard-working solutions to match. Solid Grade Laminate (SGL) is built to last and is totally impervious to water. Plus, it comes in a choice of 34 on-trend colours.



01 Solid Surface WT3 profile concealed waste washtrough with brackets.

02 Solid Surface vanity with Concept Sphere semi-recessed basins and silver dual lever monoblock mixer taps.

03 SGL vanity with Concept Sphere semi-recessed basins and Avon 21 mixer taps.

04 SGL vanity with Orbit basins and Avon pillar taps.

Vanities HPL

High Pressure Laminate (HPL) is highly economical, delivering top marks on finish and design and a superb choice for any dry environment. Ensuring maximum choice, it comes with a selection of vanity profiles and in a choice of 34 colours.



01 Baby change unit with Orbit basins and Tratto lever monoblock taps.

02 HPL K2 profile vanity unit in Shadow and Cloud with Sandringham 21 500 semi-recessed basins, SanCeram basin mounted self-closing mixer tap and a white ABS liquid soap dispenser.

Main image

Lollipop HPL vanity in Olive, Peony and Soft Oak with Sandringham 21 semi-recessed basins, Sandringham 21 self closing pillar taps and a white ABS liquid soap dispenser.

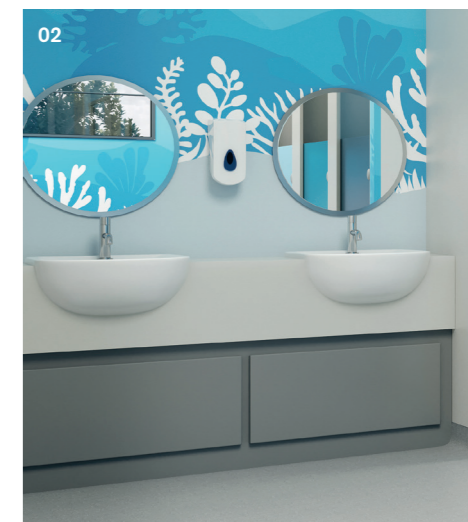

Technical Specifying Vanities

Solid Surface 13mm blend of acrylic polymer minerals with integral moulded-in-reinforcements that provide impact and thermal shock resistance. Suitable for heavy duty applications. Maximum single Solid Surface vanity unit length is 3000mm.

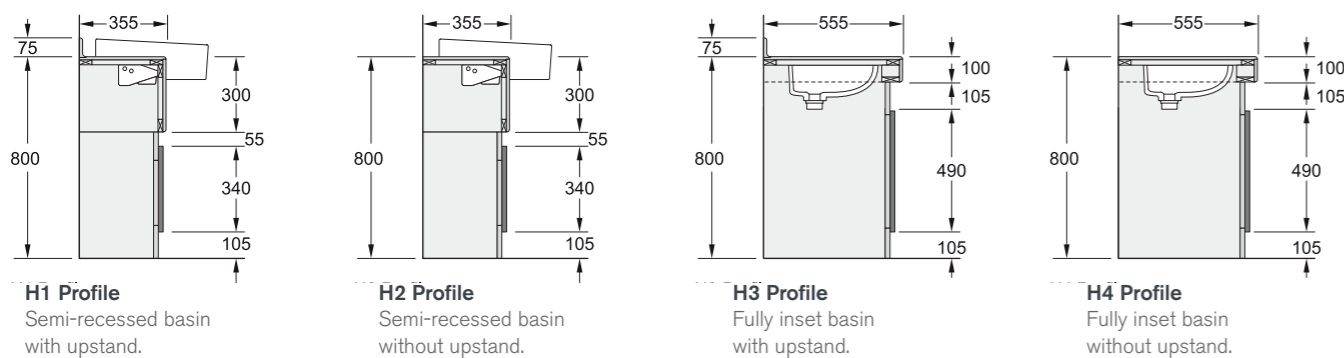

Solid Surface Washtrough Maximum single Solid Surface washtrough length is 3000mm. Any stud framework is by site.

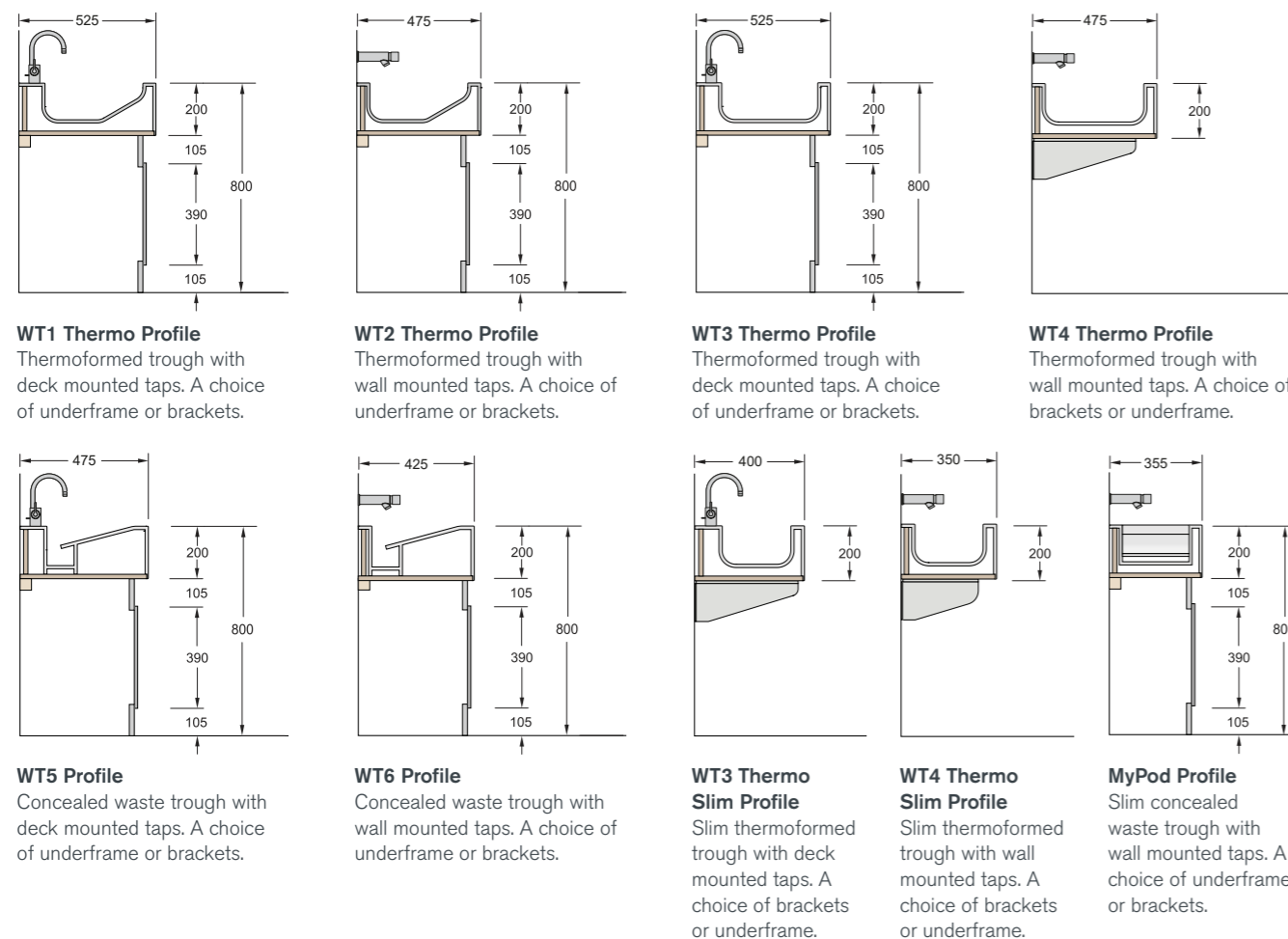

HPL For light and medium duty applications. High performance moisture resistant chipboard faced with high pressure laminate with post-forming to horizontal edges of under panels. Vertical edges are lipped with ABS. Maximum single HPL vanity unit length is 2770mm.

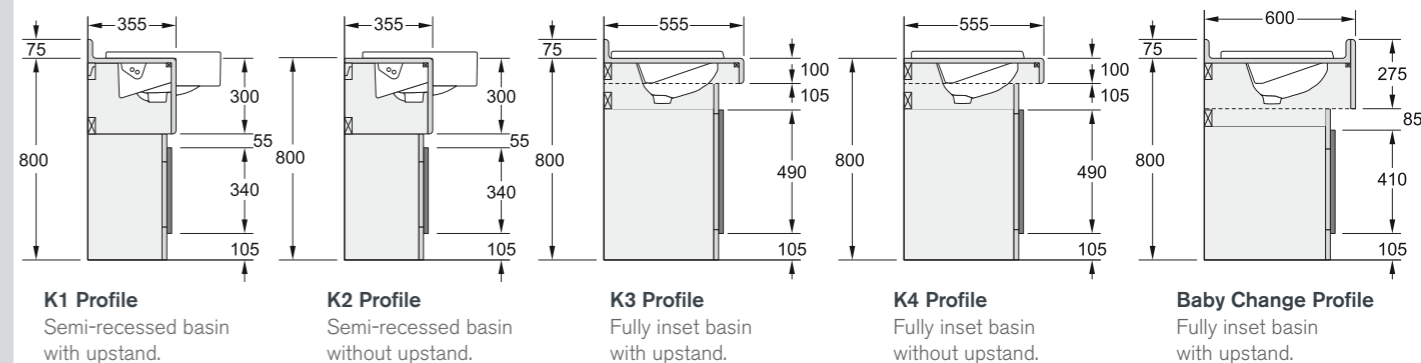

SGL Suitable for wet and heavy duty applications. 13mm nominal thickness with polished black radiused edges. SGL vanities come with powder coated aluminium extrusions in Satin Anodised Aluminium or Black Anodised Aluminium. Maximum single SGL vanity unit length is 2770mm.

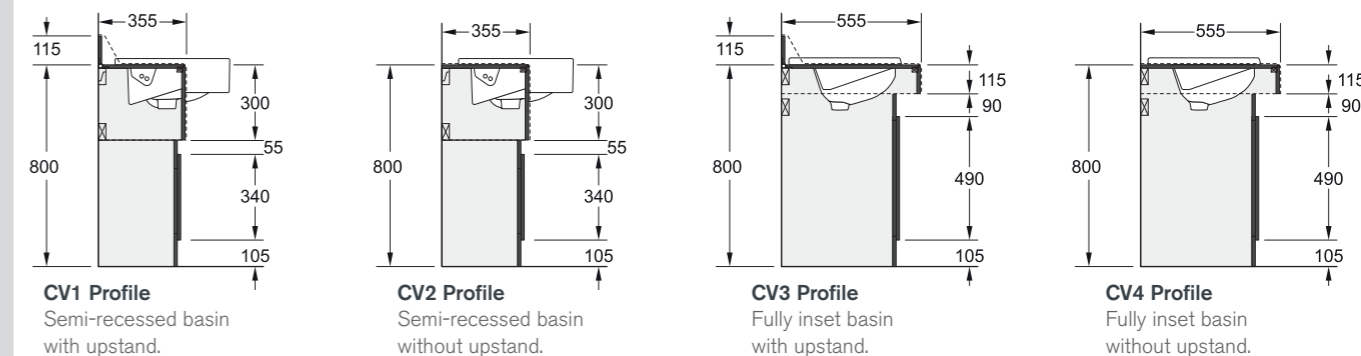

Granite and Quartz Maximum single Granite vanity unit length is 2770mm. Maximum single Quartz vanity unit length is 2400mm.

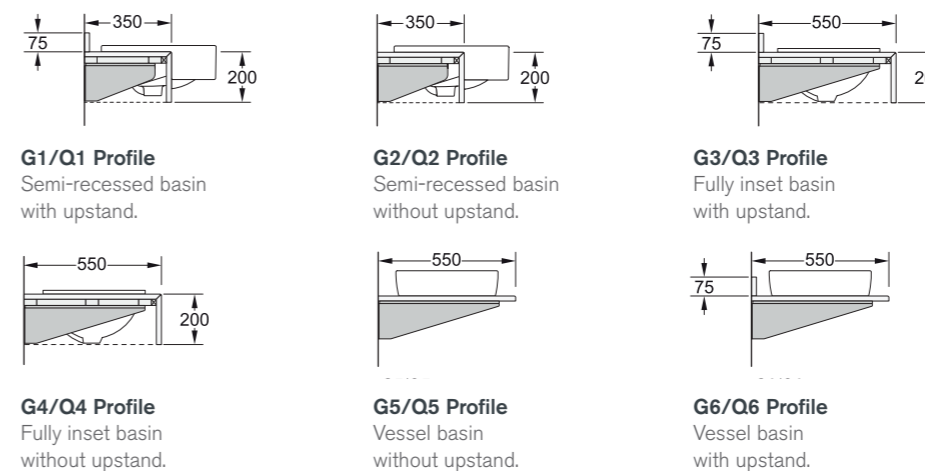

Light Pelmet All fixing brackets included. Broken line indicates return end detail.

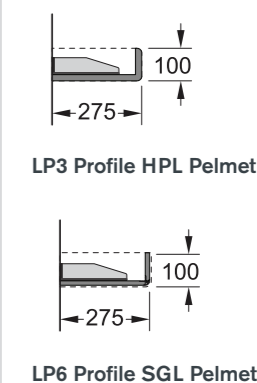

Lockers and benches

For over 40 years, we've been designing and manufacturing lockers and benches for education and leisure environments. So whatever environment you're working in, you can rely on our stylish and flexible, tried and tested locker and bench solutions to seamlessly fit and perfectly enhance your space.

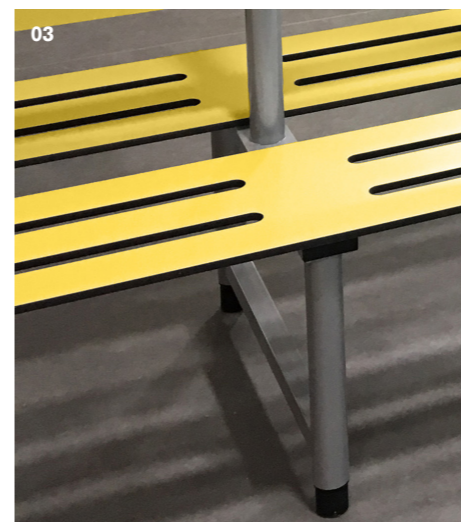

Main image
Active Lockers,
Model 3.

01 Internal coat hook, available on Model 1, Model 2 and Model Z lockers.

02 13mm SGL doors with integrated hinge design and SGL internal shelf.

03 SGL pocket benching.

04 SGL bench coat hook.

05 Cam lock.

06 Coin return lock.

07 Digi lock.

08 Coin retain lock.

09 RFID lock.

10 Hasp lock.

See p104-105 for locker and bench technical specifications.

05



06



07



08



09



10



Technical Specifying lockers and benches

Lockers

Active locker 300mm width

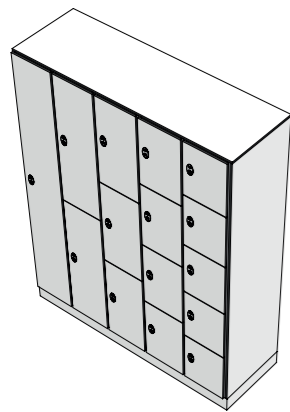

Opening sizes

- Model 1** 1774 x 266mm
- Model 2** 880 x 266mm
- Model 3** 583 x 266mm
- Model 4** 434 x 266mm
- Model 5** 345 x 266mm

Active locker 400mm width

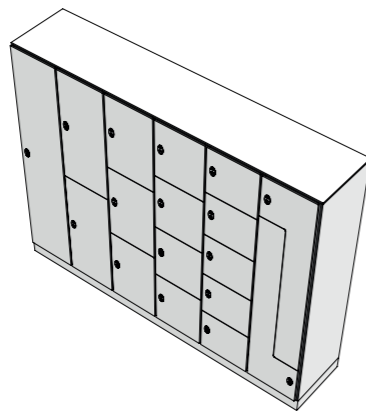

Opening sizes

- Model 1** 1774 x 366mm
- Model 2** 880 x 366mm
- Model 3** 583 x 366mm
- Model 4** 434 x 366mm
- Model 5** 345 x 366mm
- Model Z** 1457 x 366mm

Bench locker 300mm width

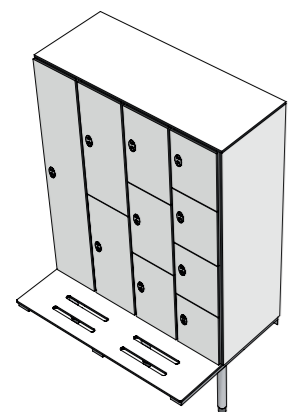

Opening sizes

- Model 1** 1434 x 266mm
- Model 2** 711 x 266mm
- Model 3** 469 x 266mm
- Model 4** 349 x 266mm

Bench locker 400mm width

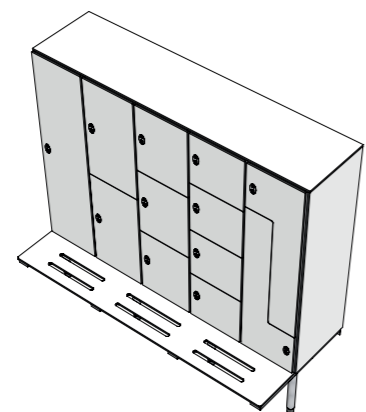

Opening sizes

- Model 1** 1434 x 366mm
- Model 2** 711 x 366mm
- Model 3** 469 x 366mm
- Model 4** 349 x 366mm
- Model Z** 1025 x 366mm

Overall height

Active lockers 1913mm
Bench lockers 1473mm from bench level

Widths

300mm (not applicable to Model Z)
400mm

Depth

510mm
840mm (including bench)

Active lockers key features

- Available in 34 laminate colours
- Robust and hardwearing
- Practical in design and functionality
- High impact resistance
- Totally impervious to water

Door performance

High impact resistant 13mm thick Solid Grade Laminate (SGL) doors with 3mm radius corners.

Body performance

Robust, hardwearing and waterproof 3mm SGL carcass in Cloud.

Dividers

Hygienic, easy to clean 13mm thick SGL horizontal shelves in Cloud or Shadow.

Hinge

Rolled stainless steel self-closing hinge.

Ventilation

3mm space between doors and frame allows air to circulate.

Locks

- Coin retain
- Coin return
- Cylinder/cam lock
- Digi lock
- RFID lock
- Hasp lock

Accessories

- Laser cut numbers for locker doors
- Nylon coat hooks as standard with Model 1, Model 2 and Model Z lockers
- Nylon coat hooks as standard with Model 1 and Model Z bench lockers
- Corresponding wristband in red or blue

Stands

Venesta recommends that the lockers are installed on a raised concrete base in wet areas. Alternatively, the lockers can be mounted on a powder coated cantilevered bench. Please contact our sales team for details.

Benches

Our benches have been designed to provide strength, safety and flexibility. Available in 2 materials (13mm SGL and 32mm hardwood) and in five profiles. Each benching solution has Light Grey (RAL9006) powder coated steel or stainless steel* tubular framework.

Box section construction is tubular with adjustable feet and hidden fixings.

These bench systems are ideal for any of our washroom or cubicle systems, in both wet and dry environments.

*Contact our friendly sales team on 01474 353333 for details on prices and lead times.

Perimeter

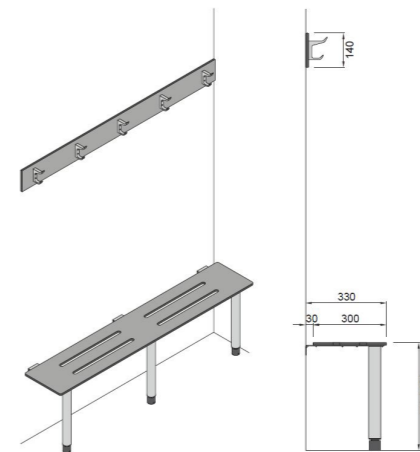

Perimeter cantilever benching

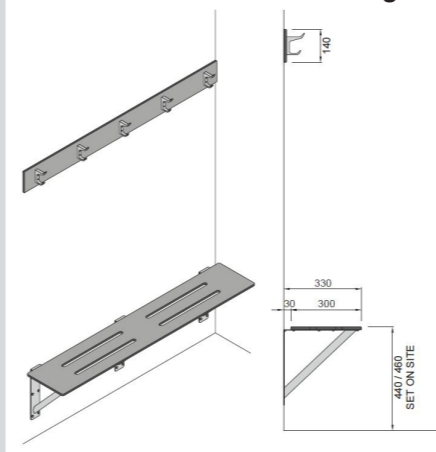

Freestanding benching

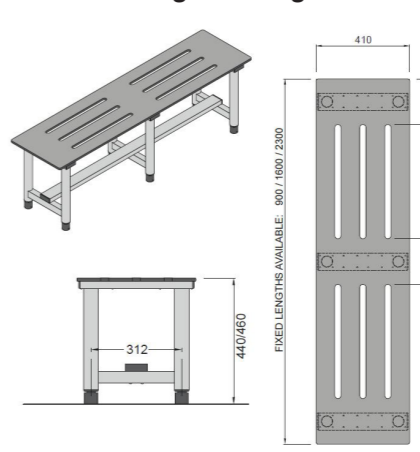

Island benching

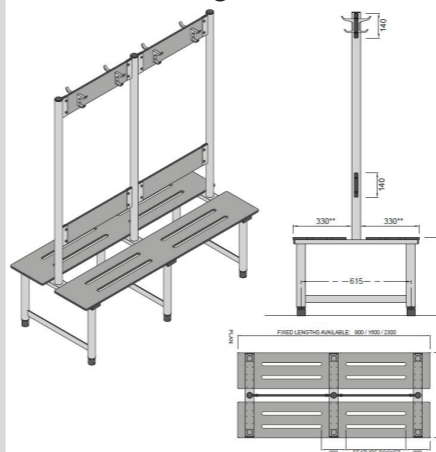

Locker benching

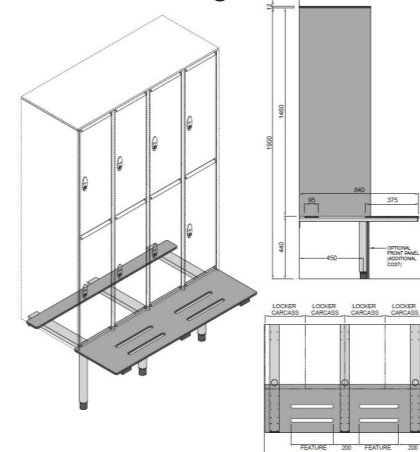

Benching key features

- Hardwearing SGL and hardwood benching options available
- Available in five profiles, each with tested tubular framework
- Ideal for wet and dry environments
- Designed for high level use
- Adjustable feet to suit uneven floors
- Optional shoe rack detail available
- Optional cubicle anti-peep rail detail available to complement coat hooks

Profiles

- Perimeter benching
- Perimeter cantilever benching
- Freestanding benching
- Island benching with integral coat hooks
- Locker benching

Dimensions

440 or 460mm bench height.

Performance

Hardwood slats in beech or SGL solid or pocket benches with double corrosion protected Light Grey powder coated steel or stainless steel* tubular frame.

Wall mounted coat hooks

13mm SGL or 20mm hardwood coat rails in beech, with satin anodised aluminium coat hooks.

*Contact our friendly sales team on 01474 353333 for details on prices and lead times.

SGL wall mounted coat hooks

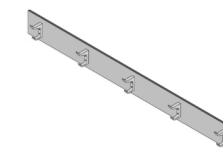

Hardwood wall mounted coat hooks

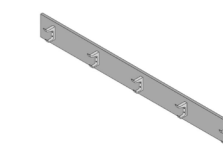

Accessories

Contemporary designs that do the job perfectly - that's our accessory range.

To make your life easier, we have everything from soap dispensers and bins to door signs and coat hooks. It's all here ready for your selection.



Paper towel dispenser
Stainless steel
Wall mounted stainless steel dispenser in brushed satin finish with key lock. Suitable for C-fold or interfold paper towels.
H300 x W262 x D128mm
Code: 0302526



Paper towel dispenser
Black/Light Grey plastic
Wall mounted ABS with stainless steel cover dispenser. Suitable for C-fold or interfold paper towels.
H325 x W325 x D150mm
Code: Black trim 0302560
Light Grey trim 0302519



Behind mirror paper towel dispenser
Stainless steel
Behind mirror mounted dispenser with hinged dispensing flaps. Suitable for interfold paper towels.
H464 x W292 x D107mm
Code: 0302531



Elite paper towel dispenser
Stainless steel
Recessed mounted dispenser in brushed satin finish with door and key lock. Suitable for C-fold or interfold paper towels.
H510 x W340 x D118mm
Code: 0302045



Paper towel 30 litre waste bin
Stainless steel
Floor standing stainless steel paper towel waste bin with brushed satin finish, bag holder and wall fixings.
H527 x W344 x D161mm
Code: 0302528



Paper towel 50 litre waste bin
Stainless steel
Floor standing stainless steel paper towel waste bin with brushed satin finish, bag holder and wall fixings.
H602 x W301 x D301mm
Code: 0302529



Elite paper towel waste bin
Stainless steel
Recessed mounted stainless steel paper towel waste bin with brushed satin finish, door latch and integral plastic liner.
H835 x W340 x D118mm
Code: 0302046



Toilet seat sanitiser
Stainless steel
A compact sanitiser unit with a high quality brushed stainless steel finish.
H196 x W98 x D97mm
Code: 0302501



Liquid soap dispenser
White metal
Wall mounted white metal liquid soap dispenser with key lock and 900ml refillable reservoir.
H251 x W108 x D91mm
Code: 0302521



Liquid soap dispenser
Stainless steel
Wall mounted stainless steel liquid soap dispenser with brushed satin finish, key lock and 900ml refillable reservoir.
H251 x W108 x D91mm
Code: 0302525



Liquid soap dispenser
Grey plastic
Wall mounted dispenser for liquid soap with Grey ABS case and stainless steel cover with 900ml refillable reservoir.
H255 x W130 x D120mm
Code: 0302513



Foam soap dispenser
Grey plastic
Wall mounted dispenser for foam soap with Grey ABS case and stainless steel cover with 900ml refillable reservoir.
H255 x W130 x D120mm
Code: 0302514



Liquid soap dispenser
White plastic
Wall mounted dispenser for liquid soap with white ABS case and 900ml refillable reservoir.
H250 x W115 x D115mm
Code: 0302540



Cylindrical liquid soap dispenser
Stainless steel
Wall mounted stainless steel soap dispenser with brushed satin finish.
H193 x Ø63 x D88mm
Code: 0302508



Paper towel dispenser
White plastic
Wall mounted white ABS dispenser for C-fold or interfold paper towels.
H425 x W290 x D145mm
Code: 0302537



Paper towel dispenser
White metal
Wall mounted metal dispenser in white powder coated finish with key lock. Suitable for C-fold or interfold paper towels.
H300 x W262 x D128mm
Code: 0302522



Lockable toilet roll holder
Light/Dark Grey plastic
Nylon single toilet roll holder with lockable arm and concealed wall fixings.
H130 x W155 x D25mm
Code: Light Grey 0300403
Dark Grey 0300147



Toilet roll holder
Light/Dark Grey plastic
Nylon single toilet roll holder with concealed wall fixings.
H130 x W155 x D25mm
Code: Light Grey 0300303
Dark Grey 0300146



Single toilet roll holder
Stainless steel
Stainless steel single toilet roll holder with concealed wall fixings.
H85 x W141 x D40mm
Code: 0302509



Double toilet roll holder
Stainless steel
Stainless steel double toilet roll holder with concealed wall fixings.
H85 x W254 x D40mm
Code: 0302510



Jumbo toilet roll dispenser
Stainless steel
Wall mounted stainless steel jumbo toilet roll dispenser with brushed satin finish, key lock and viewing slot.
Ø320 x H320 x D125mm
Code: 0302500



Jumbo toilet roll dispenser
White metal
Wall mounted white powder coated metal jumbo toilet roll dispenser with key lock and viewing slot.
Ø320 x H320 x D125mm
Code: 0302523



Midi-jumbo toilet roll dispenser
Black plastic
Wall mounted jumbo toilet roll dispenser in Black ABS case and stainless steel cover, with spare stub roll.
H350 x W260 x D140mm
Code: 0302518



Midi-jumbo toilet roll dispenser
White plastic
Wall mounted white ABS jumbo toilet roll dispenser.
H325 x W280 x D145mm
Code: 0302538



Toilet tissue dispenser
White plastic
Wall mounted white ABS toilet tissue dispenser.
H275 x W150 x D130mm
Code: 0302539



Slimline warm air hand dryer
Stainless steel
Surface mounted slimline warm air hand dryer, with low energy twin blowers and touch-free start/stop sensors.
H345 x W350 x D100mm
Code: 0302520



Automatic high speed hand dryer
Metallic silver
Compact high speed hand dryer with low energy consumption, touch-free start/stop sensor and metallic silver cast aluminium cover.
H300 x W280 x D175mm
Code: 0302535



Automatic high speed hand dryer
White metal
Compact high speed hand dryer with low energy consumption, touch-free start/stop sensor and white cast aluminium cover.
H300 x W280 x D175mm
Code: 0302533



Automatic jet hand dryer
Metallic silver
High speed jet hand dryer with metallic silver ABS cover, auto start/stop sensors and low energy consumption.
H670 x W300 x D219mm
Code: 0302536



Automatic jet hand dryer
White
High speed jet hand dryer with white ABS cover, auto start/stop sensors and low energy consumption.
H650 x W292 x D250mm
Code: 0302534



Back support rail
Satin stainless steel
Aluminium back rest 400mm long with concealed fixings and white vinyl pad.
W400 x D310 x Ø35mm
Code: Rail only S6466MY
Pad only S688467



Back support rail
White
Aluminium back rest with white polyester coated finish, concealed fixings and white vinyl pad.
W400 x D310 x Ø35mm
Code: Rail only S6466AC
Pad only S688467



800mm hinged grab rail
Powder coated stainless steel
Doc M and HBN compliant.
W800 x Ø35mm
Code: White GRAB203
Blue GRAB206
Light Grey GRAB209
Dark Grey GRAB212

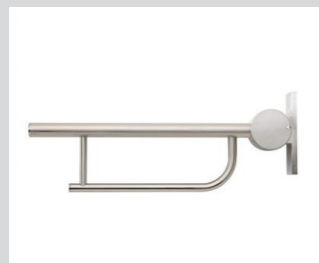

Hinged support rail
Stainless steel
Support rail in polished stainless steel with hinged support arm 800mm long and concealed fixing plate.
L800 x H242 x W110mm
Code: S6360MY

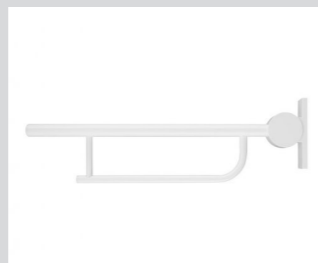

Hinged support rail
White
Support rail in white with hinged support arm 800mm long and concealed fixing plate.
L800 x H242 x W110mm
Code: S6360AC



Cubicle door pull handle
Satin stainless steel
Pair of stainless steel pull door handles with brushed satin finish and concealed fixings.
H619 x Ø19 x D65mm
Code: Pair 0302511



Cubicle door pull handle
Satin stainless steel
Stainless steel cubicle door pull handle(s) with satin finish and concealed fixings.
L225 x D45 x Ø19mm
Code: Single 0182221
Pair 0182218



Cubicle door pull handle
Satin stainless steel
Stainless steel cubicle door pull handle(s) with satin finish and concealed fixings.
L400 x D45 x Ø19mm
Code: Single 0182216
Pair 0182232



Cubicle door pull handle
Polished aluminium
Pair of polished aluminium cubicle door handles with a polished anodised powder coated finish.
H175 x W150 x D80mm
Code: Pair 0500101



600mm grab rail/fixing kit
White polyester coated aluminium
White polyester coated aluminium grab rail with concealed fixings. Fixing plate kit for cubicle mounted grab rails.
W600 x D95 x Ø80/Ø32
Code: Single S6454AC
Fixing kit 0500021



600mm grab rail/fixing kit
Polished aluminium
Polished aluminium grab rail with concealed fixings. Fixing plate kit for cubicle mounted grab rails.
W600 x D95 x Ø80/Ø32
Code: Single S6454MY
Fixing kit 0500021



455mm straight grab rail
Powder coated stainless steel
Doc M and HBN compliant.
W455 x Ø35mm
Code: White GRAB201
Blue GRAB204
Light Grey GRAB207
Dark Grey GRAB210



600mm straight grab rail
Powder coated stainless steel
Doc M and HBN compliant.
W600 x Ø35mm
Code: White GRAB202
Blue GRAB205
Light Grey GRAB208
Dark Grey GRAB211



Single coat hook
White plastic
Nylon lightweight single coat hook in White with concealed fixings.
H50 x W20 x D38mm
Code: 0300201



Single coat hook
Light Grey plastic
Nylon lightweight single coat hook in Light Grey with concealed fixings.
H50 x W20 x D38mm
Code: 0300139



Single coat hook
Dark Grey plastic
Nylon lightweight single coat hook in Dark Grey with concealed fixings.
H50 x W20 x D38mm
Code: 0300137



Single coat hook 30mm
Stainless steel
Single coat hook with concealed fixings and precision made groove retained buffer. 30kg load tested.
Ø13 x D30mm
Code: MFC/HPL/CC CH30T
SGL CH30SG



Single coat hook 65mm
Stainless steel
Single coat hook with concealed fixings and precision made groove retained buffer. 30kg load tested.
Ø50 x D65mm
Code: MFC/HPL/CC CH65T
SGL CH65SG

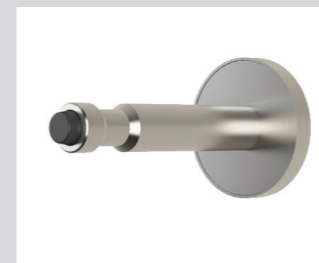

Single coat hook 90mm
Stainless steel
Single coat hook with concealed fixings and precision made groove retained buffer. 30kg load tested.
Ø50 x D90mm
Code: MFC/HPL/CC CH90T
SGL CH90SG



Male WC door sign
Stainless steel
Stainless steel self adhesive male WC door sign.
Ø76mm
Code: 0302563



Female WC door sign
Stainless steel
Stainless steel self adhesive female WC door sign.
Ø76mm
Code: 0302564



Unisex WC door sign
Stainless steel
Stainless steel self adhesive unisex WC door sign.
Ø76mm
Code: 0302565



Disabled WC door sign
Stainless steel
Stainless steel self adhesive disabled WC door sign.
Ø76mm
Code: 0302566



Baby change WC door sign
Stainless steel
Stainless steel self adhesive baby change WC door sign.
Ø76mm
Code: 0302567

We know our responsibility.

Your world is our world. At Venesta, we treat the environment the way we treat our customers, with care and commitment.

Managing our waste

Targeting zero waste

Waste is an inevitable part of any manufacturing process, but there are ways to ensure it doesn't become an environmental headache. In 2016 we set ourselves a challenge to reduce and if possible, totally eliminate our waste.

We are incredibly proud to say that in 2019 we became the first UK washroom manufacturer to achieve our target of 0% board waste to landfill.

A £1M investment into a new, state-of-the-art 1.75MW biomass burner has enabled us to eliminate MDF and HPL board waste; our smaller burner incinerates non-biomass waste like Solid Grade Laminate.

The cost of energy and the issue of carbon emissions are high on our environmental agenda and we are continually searching for ways to reduce energy consumption. Our biomass facility generates enough renewable energy to independently heat our entire manufacturing facility and office buildings.

We know our responsibility and Venesta is totally committed to making a positive impact on the environment. We treat the environment the way we treat our customers, with care and commitment.

FSC® certification

Take care of the forest

As our customer, you can be confident that our materials and products have been checked at every stage of processing to ensure we are sourcing from sustainable and ethical sources.

We only purchase wood-based panel products from suppliers who are independently certified from either FSC® (Forest Stewardship Council®) or PEFC (Programme for the Endorsement of Forest Certification).

Our V3 Veneer range is FSC® MIX certified with a full chain of custody available for our customers.

Laminate product materials are supplied to us as an FSC® accredited product under 'FSC® Controlled Wood'. Certificates are available to our customers upon request to demonstrate this.

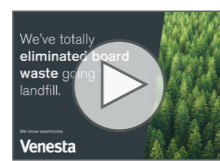

Learn about our biomass burner which has helped us achieve 0% board waste going to landfill by watching the dedicated video on our YouTube channel.

Reducing our travel

Decreasing carbon emissions

As part of our ongoing commitment to improve our carbon footprint, we've tasked ourselves with reducing employees' travelling time. All staff are encouraged to use public transport wherever possible and we've installed video conferencing facilities on all of our sites to allow meetings to be held without the need for travel.



The mark of responsible forestry
FSC® C137315



01-02 Waste management

Biomass burner turns production waste into factory and office heating.

03 Recycling

Wherever possible, all off-cuts are worked back into production for smaller product components.

04 Boilers

Our biomass burner has helped us achieve our 0% waste to landfill target.

05 Efficiency

Robotic handling systems ensure maximum board utilisation is achieved.



We know good service.

The quality of our products is only half the story. We know that excellent service can make all the difference to your satisfaction.

Our 7-stage service plan

Whether it's a simple vanity unit or an extensive refit, you'll always find we go the extra mile to ensure you're happy. Here's our 7-stage service plan.

Stage 1 Specification

Our dedicated team of Specification Managers will help you choose the most cost effective and suitable products for your project without compromising on aesthetics and quality. To help you, our NBS specification writing service is available free of charge to guide you through all the detail. With our remote specification service, the process is quick and easy. Simply send over your drawings and your local Specification Manager will provide you with a comprehensive specification tailored to your project. Remember, whenever you need advice of any kind, just call our helpful sales team, who can also provide you with product literature and material samples.

Stage 2 Estimating

Our estimating service levels have never been stronger; it's our aim to never deliver a late quotation. We pride ourselves on our attention to detail, so our comprehensive quotations always give the most detailed breakdowns of materials and prices. Don't forget, our dedicated technical helpline is here to give you technical support on all our products at any stage of the estimating and ordering process.

Stage 3

CAD

Once your order is placed, our highly skilled CAD Technicians will prepare layout drawings. At this stage, you'll be given a dedicated CAD Technician to work with you throughout your project. Everything from dimensions, colours and drawings can be sent for your approval prior to manufacture.

Stage 4 Manufacture and delivery

We're committed to delivering your order as soon as we possibly can, wherever you are in the world. With that in mind, we've invested £5m in state-of-the-art machinery - allowing us to streamline our manufacturing process to make it more efficient than ever before. 100% on time, in full with no errors is our aim and we monitor our performance closely to ensure we can deliver on this.

Stage 5 Installation

Our highly responsive technical helpline is here to give you technical support throughout the installation process. It's worth remembering that although we're a supply only company, if you need fitting too, there are Accredited Installers we can recommend who have vast experience installing our products. Accredited Installers undergo a rigorous training and approval process so you can be assured of a top quality job.

Stage 6

After sales support and spares

Once your products have been delivered, we'll give you your own dedicated point of contact to efficiently deal with all your after sales needs. Attentive and highly empathetic to your needs, they'll ensure you're completely happy at all times with our service.

Stage 7 Spares website

Our spares website has been created to make it as easy as possible for you to purchase spare items for your Venesta products. Whether it's a toilet cubicle lock, a pedestal leg, headrail end caps, washroom cubicle hinges or door buffers, it's easy to find what you are looking for on our Venesta spare parts website. You'll find everything you need at www.venesta-spares.co.uk.

One final thing, at Venesta, we appreciate customer feedback; it helps us to ensure we can continue to improve what we do in line with your needs. So, if you have any comments on our products or service, we want to hear them. You can call us on 01474 353333.



01 Sample service

Our helpful sales team can provide you with product literature and samples.

02 Technical drawings

Everything from dimensions, colours and drawings can be sent for your approval prior to manufacture.

03 Dedicated technical helpline

When you're ready to specify, our dedicated technical helpline offers you all the technical support you need.

04 Design team

A Specification Manager will talk through your washroom requirements to help you choose the most suitable products for your project.

We know washrooms. Your partner, every step of the way.

Venesta is passionate about ensuring you get the very best product and service, whatever the size of the project. That's why, from your first enquiry through to installation and beyond, you'll have a team of talented and committed experts working tirelessly to ensure you're happy and satisfied.

At Venesta, we believe it's our people that make the real difference to our business success. Everyone is an expert in their field, from our highly creative CAD team to our efficient and responsive Project Managers and our dedicated manufacturing team. Their experience and professionalism is what underpins the quality of our customer relationships.

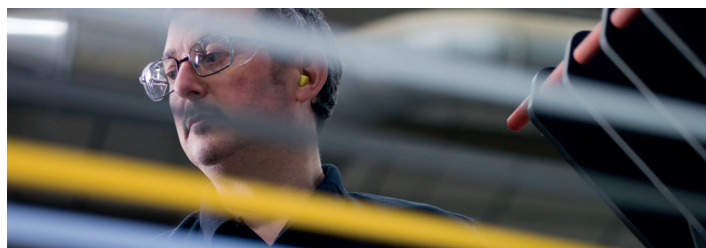

How can we help you?

Our friendly and knowledgeable team is waiting to advise you on your project. Call us on **01474 353333**.

Alternatively, you can see all our products online at **www.venesta.co.uk**. We look forward to working with you.

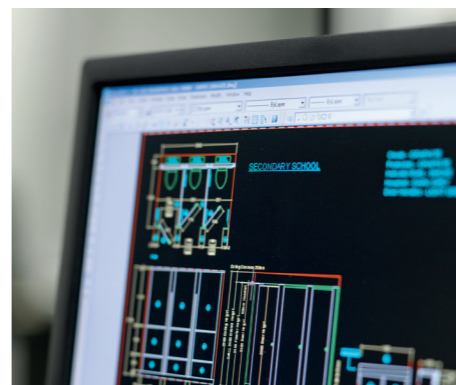

www.venesta.co.uk

For help and advice on choosing
your washroom, visit our website
for a comprehensive guide.

Our address

1st Floor, Units 19-23
St George's Square
St George's Centre
Gravesend
Kent, DA11 0TA
United Kingdom

Telephone
+44 (0) 1474 353333

Email
marketing@venesta.co.uk

Republic of Ireland
Telephone
1 800 931 880

Middle East
Telephone
+971 6 5533361

www.venesta.co.uk

www.venesta-international.co.uk

www.venesta-spares.co.uk